



# aquatherm red pipe

**Pipe system made of polypropylene**  
for fire sprinkler systems



**aquatherm**

state of the pipe



## NEW SINCE THE LAST VERSION

**Page**    **Change**

–        Article Number Overhaul.



**Dear readers,**

We are always making decisions – in every minute of every hour of every day. At this moment, you have decided to open our catalogue to consciously find out more about our company aquatherm.

Without knowing the reason behind your decision, we can promise you one thing, namely that the insight into our colourful, yet always slightly green tinged, aquatherm world is sure to impress you!

As a family business which is passionate about all it does we, together with our employees, confidently meet all challenges and, in doing so, are able to trustfully call upon values which have defined our company for already more than four successful decades.

We know where we want to go without forgetting where we came from. Hereby we like to live with the role of not being a “normal” business. The characteristics “being different” and “special” represent our motivation in all that we do to be the best.

We are “state of the pipe” because we act independently and decisively and are hereby always reliable which makes us the leading manufacturer of polypropylene pipes.

We were, are and will remain as this – promise!

But see for yourself and decide upon aquatherm not only in the next few moments but also in the long term.

Best wishes

**Christof Rosenberg**  
Managing Director

**Dirk Rosenberg**  
Managing Director

**Maik Rosenberg**  
Managing Director

**Gerhard Rosenberg**  
President of the Advisory Board

- 1973 aquatherm founded by Gerhard Rosenberg
- 1981 development of the first pipe system made of polypropylene; the colour green becomes a characteristic feature of aquatherm
- 1991 subsidiary Radeberg was founded
- 1996 first certification of the quality management system in accordance with ISO 9001
- 1997 foundation of the sales company in Italy
- 1999 development of fusiotherm® fibre composite pipe
- 2001 aquatherm operates in more than 50 export markets
- 2002 market launch of the aquatherm blue pipe
- 2005 market launch of the aquatherm red pipe and aquatherm black system
- 2010 system expansion of the pipe size to max. ø630 mm
- 2010 Christof, Dirk and Maik Rosenberg assume company management
- 2012 first certification of the environment management system in accordance with ISO 14001
- 2012 market launch of the material fusiotherm® PP-RP
- 2013 first certification of the energy management system in accordance with ISO 50001
- 2015 foundation of the sales company in North America
- 2017 opening of the new pipe extrusion plant
- 2018 opening of the new injection moulding facility
- 2018 foundation of the sales company in England
- 2019 expansion of the industrial prefabrication operation
- 2021 participation in the distribution company aquatherm ibérica s.l.



**TABLE OF CONTENTS**

**General**

Material properties/Advantages	8
Processing	9
International approvals	11
Handling/Transport/Storage	12

**Product catalogue**

Product catalogue	13
Pipe/Socket	
Reducer/Elbow	
Tee/Cross	
Sprinkler outlet/End cap/Weld-in saddle	
Compensating joint	
Weldable flange adapter/flange/	
Transition piece/Transition elbow	
Threaded branch tee	
Weld-in saddle/Pipe cutter	
Welding device	
Welding accessories	
Welding tool/Drill	
Adjusting tool	

**Fusion**

Part A:	
Mounting of the tools	35
Heat-up phase	36
Handling	36
Guidelines	36
Part B:	
Checking of devices and tools	37
Preparation for the fusion	38
Heating of pipe and fittings	39
Setting and alignment	39
Visual inspection of fusion seam	40
Part C:	
Weld-in saddles	42
Drilling, heat-up, joining, fixing	43
Part D:	
Welding machine	44
Support intervals	
Part E:	
Welding machine light	45
Part F:	
Repair	45
Part G:	
Butt-welding of pipe dimension 160 mm	46
Visual inspection of fusion seam (butt welding)	48
Welding parameters	50

**Laying of aquatherm red pipe in the concrete**

Part 1:	51
Connecting of pipe work to the sprinkler outlet	
Part 2:	59
Pressure test of pipe work installation as strength test and leak test	
Part 3:	59
What must be considered during the concreting process?	
Part 4:	60
Bridging of building joints	
Part 5:	60
Potential equalizing	
Part 6:	60
Pressurizing in the aquatherm red pipe supply during the concreting process	
Part 7:	60
Influence of the concrete to the applied compounds	

**Test**

Leakage test/Pressure diagram	
Test record aquatherm red pipe system installation	
Form: "Inquiry for the chemical resistance"	

**Warranty**

66

**References**

68

# SERVICE

## TECHNICAL HOTLINE +49 2722 950 200

info@aquatherm.de www.aquatherm.de

### Headquarters Attendorf

**aquatherm GmbH**  
Biggen 5  
57439 Attendorf  
Germany  
Phone: +49 2722 950 0

### Subsidiary Radeberg

**aquatherm GmbH**  
Wilhelm-Rönsch-Str. 4  
01454 Radeberg  
Germany  
Phone: +49 3528 4362 0



#### Technical sales

Whether briefing on site, system briefing in your workshop or counter events and tool days at the specialized trade: In addition to the regular training in Attendorf, the aquatherm application engineers are every day and everywhere in Germany on the way.

A list of our partners worldwide can be found on our website [www.aquatherm.de](http://www.aquatherm.de) in the category „contact“.



#### Training

In addition to the proven lectures and counter events in the specialized trade and the training at the guild associations, aquatherm regularly offers specialist seminars and information events at the training center in Attendorf.

#### Trade shows

aquatherm is represented with its own booth at all important sanitary and HVAC trade shows in Germany and abroad. Information on trade fair dates in your area are available at [www.aquatherm.de](http://www.aquatherm.de) in the „service“ area.

## Certifications in accordance with ISO 9001, 14001 & 50001

Since 1996 aquatherm fulfills the requirements of the quality management system according to DIN ISO 9001. The 2012 TÜV certificate was extended by the environmental management system according to ISO 14001 and currently by the energy management system according to ISO 50001.

This success is another step towards strengthening our competitive position and to meet the high requirements and the responsibility for our customers, partners and the environment.



### Laboratory

From testing of granulate properties to permanent process monitoring: Only perfect goods have the chance to leave aquatherm.



### Software service

The aquatherm software service provides Datanorm files, BIM-compatible files, an independent graphical configuration program (liNear) as well as the appropriate training on site.



### Brochures and more

No matter whether brochures, catalogues or product lists are concerned: Everything is developed by our in-house marketing department. All documents can be downloaded as PDF from our website [www.aquatherm.de](http://www.aquatherm.de). For printed copies just send an e-mail to [infoservice@aquatherm.de](mailto:infoservice@aquatherm.de).

# SERVICE

# aquatherm red pipe

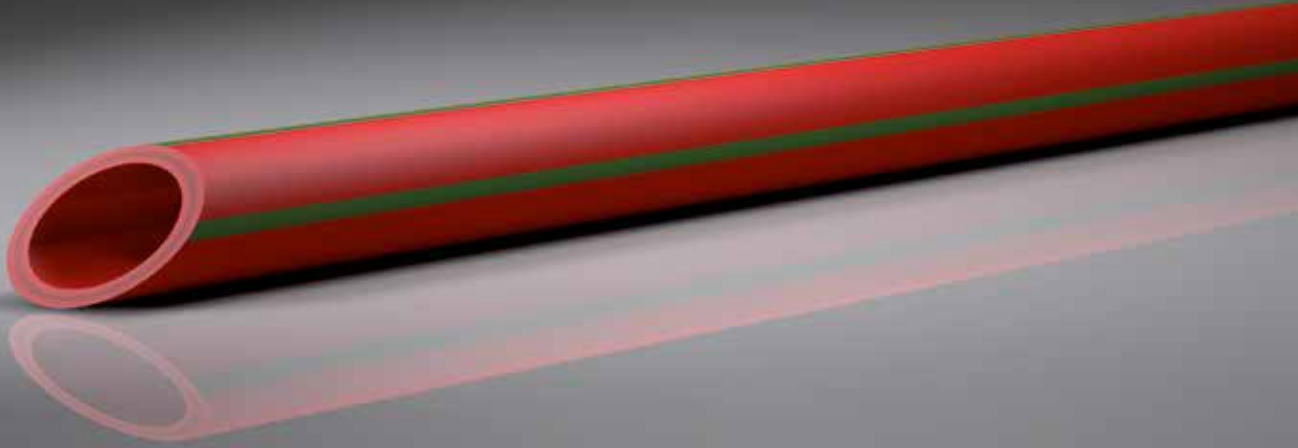

## aquatherm red pipe

### Effective, safe, invisible:

aquatherm red pipe is a multiple certified plastic sprinkler piping system. It is composed of fusiolen® PP-R FS, which was developed for the special requirements of sprinkler systems. Due to its flame-retardant properties and its corrosion resistance, aquatherm red pipe offers a high degree of safety. The heat fusion process used to join aquatherm red pipe and fittings ensures a tight, safe, and virtually leak-free connection. Thanks to aquatherm red pipe, effective fire protection and spectacular architecture are not mutually exclusive: the piping system is suitable for laying in concrete, thus guaranteeing invisible protection that ensures architectural freedom of design.

aquatherm red pipe system is suitable for classic wet sprinkler systems (in concrete or F30 ceiling areas), and also for low-pressure fine-mist systems. These systems use substantially less extinguishing water than conventional sprinkler systems and thus reduce damage to buildings and equipment.

### ADVANTAGES

- Certified and quality inspected
- Connection by fusion welding
- Resistant against corrosion and chemicals
- No accumulation of corrosion products
- Low pipe roughness factor and high abrasion resistance
- Heat- and sound-insulating characteristics
- High impact strength
- Leak-proof connection of pipe and fitting by fusion technique
- Not easily flammable acc. to DIN 4102-1, building material class B1
- Low weight compared to metal pipes
- Short processing time
- No gaskets – sealing elements are not required
- 3-layer pipe with fibre glass reinforced inner layer
- Concealed fire protection
- Reduction of structural work costs by laying in concrete
- Improved assembly times due to industrial prefabrication
- Year-round processing in compliance with Technical Code DVS 2207-11

aquatherm red pipe offers an extensive range of pipes and fittings for the installation of fire sprinkler systems.

The system is based on a fibre reinforced polypropylene pipe (fibre composite pipe) produced in a multi-layer extrusion process.

### aquatherm red pipe is:

#### Connected by fusion welding

No sealants or adhesives are required for this permanent connection.

#### Corrosion-proof

Prevents the clogging of the sprinkler with corrosive material.

This ensures a long, low-maintenance service life as well as failure-free functioning of the system.

The production of pipes and fittings is controlled according to the highest quality standards on most modern injection moulding machines and extrusion lines. The high quality of our products is guaranteed by extensive controls of incoming goods and the production process.



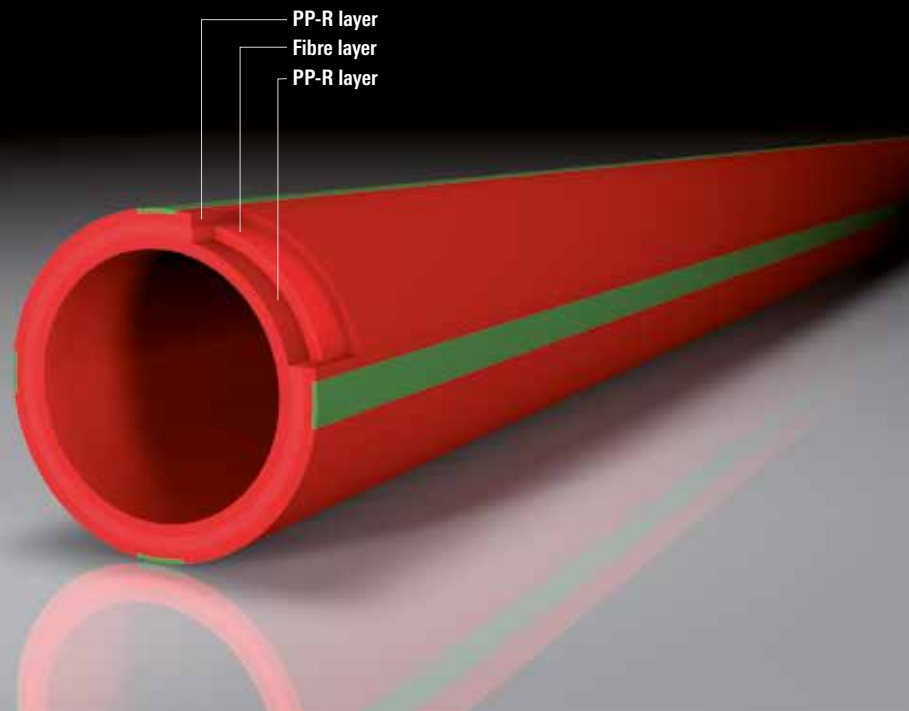

## PROCESSING

### Fusion technique

By the fusion of pipe and fitting the plastic melts to a homogeneous material unit.

Pipe and fitting are heated quickly with specially provided welding tools and joined together – finished!

Double material thickness at the joint – giving double safety at the otherwise critical point of a pipe system.

A permanent leakproof connection is created with the aquatherm fusion technique.

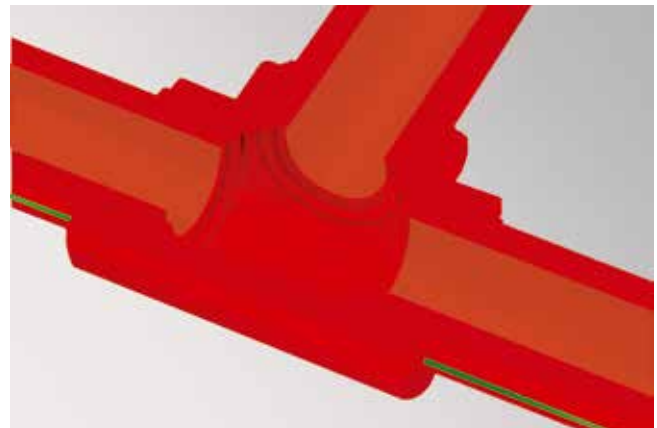

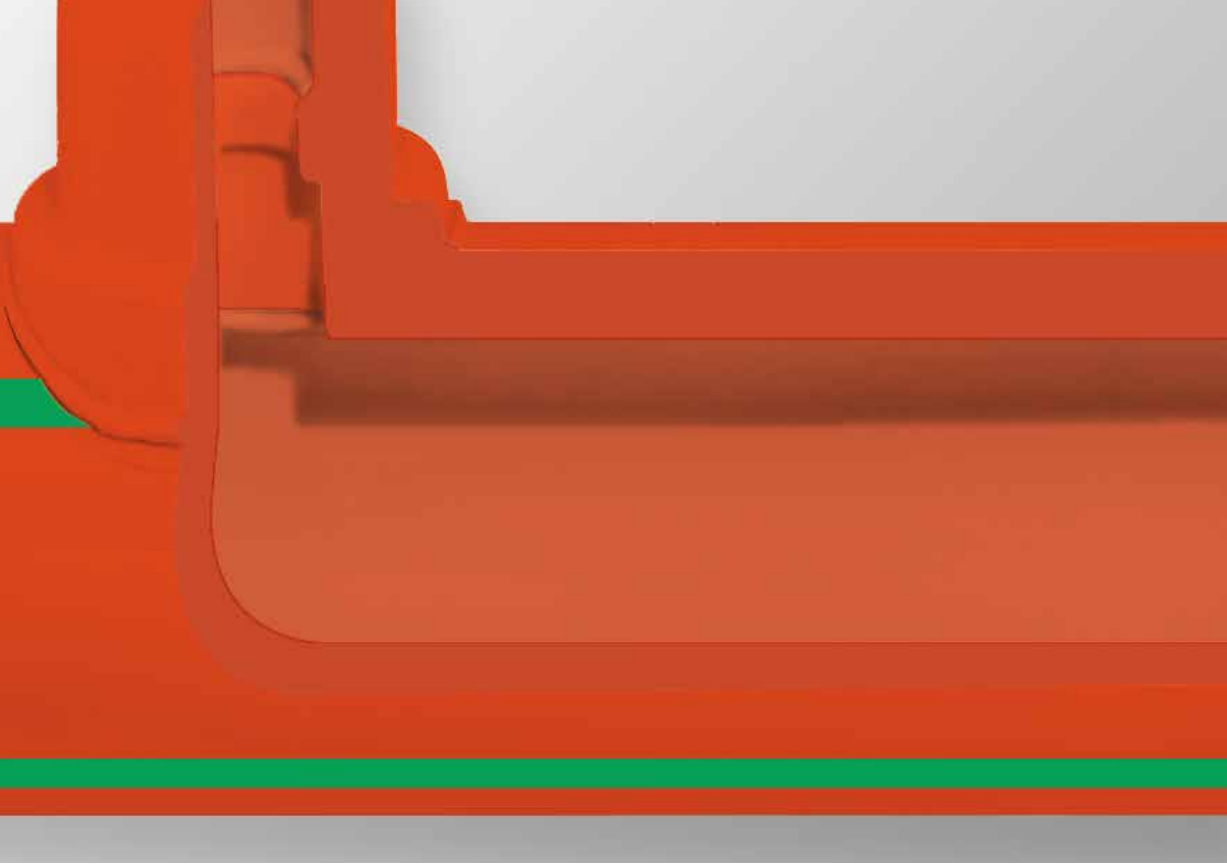

## PROCESSING

### Weld-in saddle technique

Branches can easily be made by weld-in saddles, even post-installation. Material costs and processing time are reduced by using weld-in saddles.

Whereas in case of tees three joints are to be processed, work is limited to mounting the saddle and the branch pipe only.

Simply drill the pipe; heat up the saddle, pipe wall and surface; connect the parts. Finished!



## INTERNATIONAL APPROVALS

### for the application as sprinkler lines

Fire protection requirements and standards for planning and construction of sprinkler systems vary locally.

Thus, the application of aquatherm red pipe in any case has to be agreed and coordinated with the local national fire protection authorities, the constructor and the building insurers.

Further certification either national or local are in process.

#### UK; LPCB:

The system of pipes and fittings must be installed in accordance with the „Technical Instruction aquatherm red pipe“ dated 01/12/2012 Issue 2. The current valid version of the „Technical Instruction aquatherm red pipe“ is available from [infoservice@aquatherm.de](mailto:infoservice@aquatherm.de).



Germany



Poland



Hong Kong



Austria



Iceland



New Zealand



FEDERAL STATE ESTABLISHMENT  
THE ALL-RUSSIAN RESEARCH  
INSTITUTE FOR FIRE PROTECTION  
(FGU VNIIPPO)

Russia



Australian  
Standard  
AS 4118.2.1  
Lic SMK P20464

Australia



LPS 1260  
Cert.-no.: 684a

Great Britain



N.º 526/09

Spain

## VeriFire

New Zealand



UkrSEPRO

Ukraine

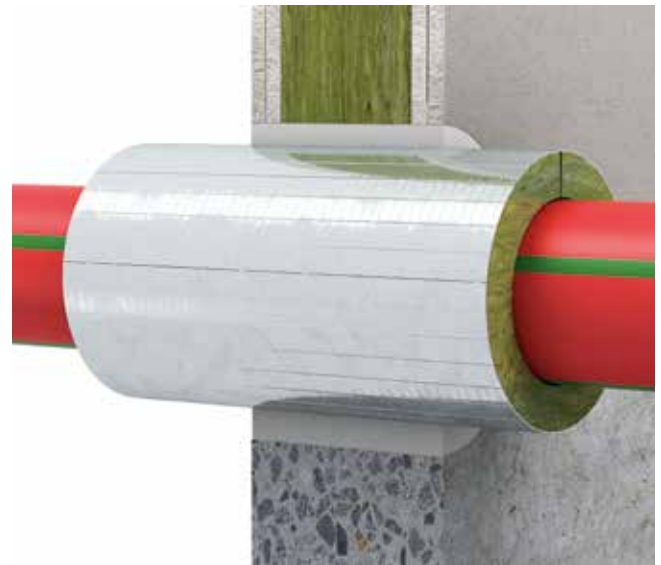

**HANDLING**

**Transport and storage**

aquatherm red pipe pipes can be stored in all outside temperatures. Pipes should be stored and transported flat and fully supported along their length. Bending pressures are to be avoided. High impact should be avoided at externally low temperatures. Although aquatherm red pipe pipes are extremely robust, it is recommended to treat the material always with care.

**UV resistance**

Pipes from fusiolen® PP-R FS should not be installed (without protection) where subject to UV-radiation. All aquatherm red pipe pipes and fittings are supplied in UV-protected packaging to bridge transport and assembly time. Ultraviolet rays have an influence on all high polymeric plastics. Hence, pipes should not be stored unprotected outside for a long time. The maximum storage time is (outside) 6 months.

**Fire bulkheading**

All fire prevention systems which can prove equivalent licensing are suited for the aquatherm red pipe system.

The following companies offer suitable fire protection solutions:

**Fire protection shell Conlit 150 U:**

**DEUTSCHE ROCKWOOL GmbH & Co. KG**

Rockwool Straße 37-41  
45966 Gladbeck, Germany  
Tel: +49 2043 408 0  
www.rockwool.de

**Fire protection collar AWM II:**

**Flamro Brandschutz Vertriebs GmbH**

Am Sportplatz 2  
56291 Leiningen  
T +49 6746 9410-0  
E info@flamro.com  
W flamro.de

**Hilti Deutschland AG**

Hiltistraße 2  
86916 Kaufering, Germany  
Tel: +49 800 888 55 22  
www.hilti.de

**Procedures for additional repair**

Cut out damaged/leaking section and replace as for a new installation or repair with pipe repair stick (page 45).

**Chemical resistance**

On account of the special material qualities aquatherm red pipe pipes and fittings provide extensive chemical resistance. aquatherm red pipe transition connections and elements with brass inserts are not suitable for all media. The compatibility should be asked at aquatherm with media deviating from water. Please use the "Inquiry for the chemical resistance" on page 65.

**Pipe friction loss**

The pressure loss caused by friction is to be calculated hydraulically with the Hazen-Williams-formula.

The value to be used for C is 150, applicable for calculations of sprinkler installations and water supply.

**Equivalent lengths for the aquatherm red pipe sprinkler pipe system**

The equivalent lengths of transition pieces, threaded connexions and tees (flow direction: straight) can be edequated with the socket values.

Pipe dimension (mm)										
Nominal Diameter	DN15	DN20	DN25	DN32	DN40	DN50	DN65	DN80	DN90	DN125
Outer diameter aquatherm red pipe	25,0 mm	32,0 mm	40,0 mm	50,0 mm	63,0 mm	75,0 mm	90,0 mm	110,0 mm	125,0 mm	160,0 mm
Article	Equivalent pipe length									
Socket	0,22	0,30	0,40	0,52	0,70	0,86	1,07	1,36	1,58	2,44
Reduction of 1 dimension	0,27	0,37	0,48	0,63	0,83	1,03	1,28	1,63	1,90	2,93
Reduction of 2 dimensions	0,36	0,49	0,64	0,84	1,11	1,37	1,71	2,17	2,53	3,91
Elbow < 90°-45°	0,67	0,91	1,20	1,57	2,09	2,57	3,20	4,07	4,74	7,33
Elbow < 45°	0,33	0,46	0,60	0,78	1,04	1,28	1,60	2,03	2,37	3,66
Standard tee or cross flow direction branch	0,98	1,34	1,76	2,30	3,06	3,76	4,70	5,96	6,96	10,75

PIPE, FITTINGS

**Material:** fusiolen® PP-R FS  
**Pipe series:** SDR 7,4  
**Packing Unit:** straight length 5.8 m  
**Colour:** red/4 green stripes

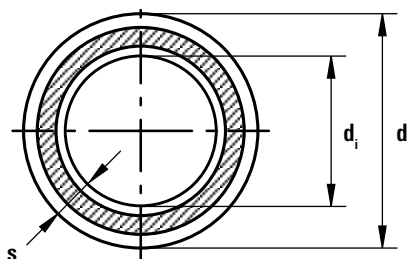

**aquatherm red pipe PIPE SDR 7,4 / B1**

Art. no.	Dimension [mm]	PU m/pc	Price € m/pc	Diameter d [mm]	Wall thickness s [mm]	Internal diameter d <sub>i</sub> [mm]	Water content [l/m]	Weight [kg/m]
3012025008	25 x 3,5	116		25	3,5	18	0,254	0,249
3012032010	32 x 4,4	58		32	4,4	23,2	0,423	0,400
3012040012	40 x 5,5	58		40	5,5	29	0,660	0,621
3012050014	50 x 6,9	29		50	6,9	36,2	1,029	0,968
3012063016	63 x 8,6	17,4		63	8,6	45,8	1,647	1,521
3012075018	75 x 10,3	17,4		75	10,3	54,4	2,323	2,165
3012090020	90 x 12,3	11,6		90	12,3	65,4	3,358	3,101
3012110022	110 x 15,1	5,8		110	15,1	79,8	4,999	4,642
3012125024	125 x 17,1	5,8		125	17,1	90,8	6,472	5,974

**Material:** fusiolen® PP-R FS  
**Pipe series:** SDR 11  
**Packing Unit:** straight length 5.8 m  
**Colour:** red/4 green stripes

**aquatherm red pipe PIPE SDR 11 / B1**

Art. no.	Dimension [mm]	PU m/pc	Price € m/pc	Diameter d [mm]	Wall thickness s [mm]	Internal diameter d <sub>i</sub> [mm]	Water content [l/m]	Weight [kg/m]
3014160026	160 x 14,6	5,8		160	14,6	130,8	13,430	6,940

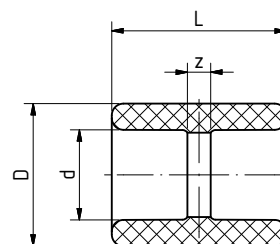
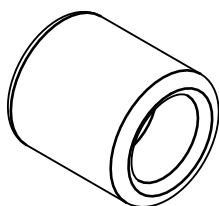

**aquatherm red pipe SOCKET / B1**

Art. no.	Dimension [mm]	PU m/pc	Price € m/pc	d [mm]	L [mm]	z [mm]	D [mm]	Weight [kg/m]
3040025020	25	10		25	35	3	34	0,014
3040032021	32	5		32	40,5	4,5	43	0,027
3040040022	40	5		40	51,5	6,5	52	0,044
3040050023	50	5		50	53	6	68	0,086
3040063024	63	1		63	60,5	5,5	84	0,145
3040075025	75	1		75	66,5	6,5	100	0,233
3040090026	90	1		90	72,5	6,5	120	0,353
3040110027	110	1		110	82	8	147	0,606
3040125028	125	1		125	92	12	167	0,819

Art. no.=article number, PU=Packing unit, d=Diameter (mm), s=wall thickness (mm), d<sub>i</sub>=internal diameter (mm), f=female thread, m=male thread

FITTINGS

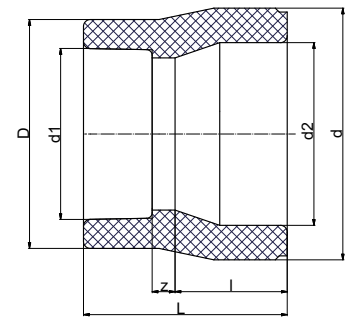
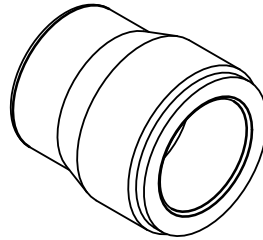

**aquatherm red pipe REDUCER / B1**

SDR	Art. no.	Dimension [mm]	PU m/pc	Price € m/pc	d [mm]	d1 [mm]	d2 [mm]	L [mm]	l [mm]	z [mm]	D [mm]	Weight [kg]
socket welding												
7,4	3040032030	32/25	5		32	25	21,00	38	18	4	34	0,016
	3040040031	40/32	5		40	32	26,50	50	20,5	11,5	43	0,033
	3040050032	50/32	5		50	32	33,50	54	23,5	12,5	43	0,054
	3040050033	50/40	5		50	40	33,50	53	23,5	9	52	0,059
	3040063034	63/50	1		63	50	42,00	63,5	27,5	12,5	68	0,122
	3040075035	75/50	1		75	50	50,00	63	30	9,5	68	0,143
	3040075036	75/63	1		75	63	50,00	71	30	13,5	84	0,173
	3040090037	90/63	1		90	63	60,00	78	33	17,5	84	0,232
	3040090038	90/75	1		90	75	60,00	81,5	33	18,5	100	0,281
	3040110039	110/63	1		110	63	73,50	86	37	21,5	84	0,363
	3040110040	110/90	1		110	90	73,50	99	37	29	120	0,564
	3040125041	125/90	1		125	90	84,00	99	40	26	120	0,831
	3040125042	125/110	1		125	110	84,00	112	40	35	147	0,811

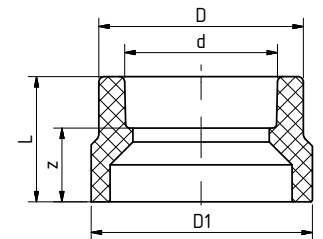
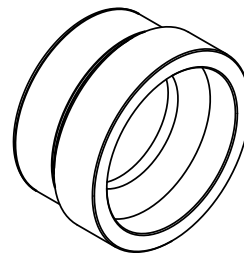

**aquatherm red pipe REDUCER / B1**

SDR	Art. no.	Dimension [mm]	PU m/pc	Price € m/pc	D1 [mm]	d [mm]	L [mm]	z [mm]	D [mm]	Weight [kg]
butt welding										
11	3044160000	160/110	1		160	110	90	53	147	0,681
	3044160001	160/125	1		160	125	90	50	167	0,729

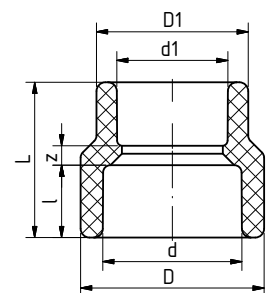
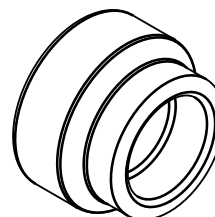

**aquatherm red pipe REDUCING SOCKET / B1**

female/female

Art. no.	Dimension [mm]	PU m/pc	Price € m/pc	d [mm]	d1 [mm]	L [mm]	l [mm]	z [mm]	D [mm]	D1 [mm]	Weight [kg]
3040063005	63/50	1		63	50	56	27,5	5	84	68	0,126
3040075006	75/63	1		75	63	62,5	30	5	100	84	0,191
3040090007	90/75	1		90	75	69	33	6	120	100	0,297

FITTINGS

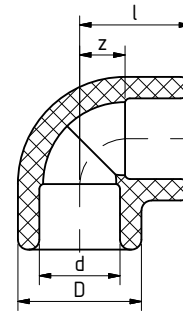
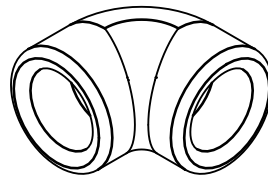

**aquatherm red pipe ELBOW 90°/ B1**

SDR	Art. no.	Dimension [mm]	PU m/pc	Price € m/pc	d [mm]	z [mm]	l [mm]	D [mm]	Weight [kg]
socket welding									
7,4	3080025001	25	10		25	13,5	29,5	34	0,023
	3080032002	32	5		32	17	35	43	0,043
	3080040003	40	5		40	21	41,5	52	0,071
	3080050004	50	5		50	26	49,5	68	0,158
	3080063005	63	1		63	32,5	60	84	0,276
	3080075006	75	1		75	38,5	68,5	100	0,446
	3080090007	90	1		90	46	79	120	0,798
	3080110008	110	1		110	56	93	147	1,323
	3080125009	125	1		125	76,5	116,5	167	2,026

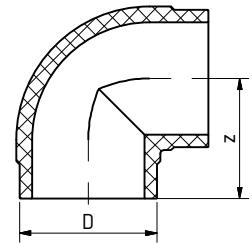
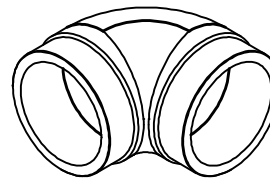

**aquatherm red pipe ELBOW 90°/ B1**

SDR	Art. no.	Dimension [mm]	PU m/pc	Price € m/pc	D [mm]	z [mm]	Weight [kg]
butt welding							
11	3084160002	160	1		160	145	1,976

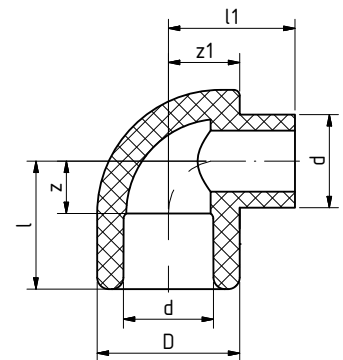
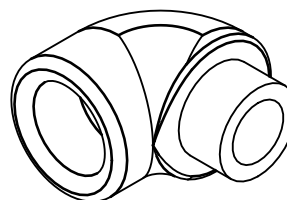

**aquatherm red pipe ELBOW 90°/ B1**

female/male

Art. no.	Dimension [mm]	PU m/pc	Price € m/pc	d [mm]	z [mm]	l [mm]	D [mm]	l1 [mm]	z1 [mm]	Weight [kg]
3080032010	32	5		32	17	35	43	39	21,5	0,049
3080040011	40	5		40	21	41,5	52	45,5	26	0,081

FITTINGS

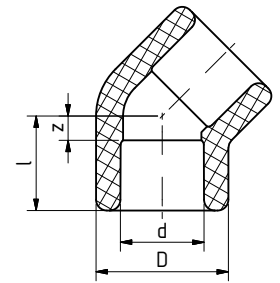
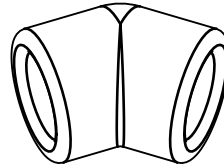

**aquatherm red pipe ELBOW 45° / B1**

SDR	Art. no.	Dimension [mm]	PU m/pc	Price € m/pc	d [mm]	z [mm]	l [mm]	D [mm]	Weight [kg]
					socket welding				
7,4	3080025020	25	10		25	6	22	34	0,019
	3080032021	32	5		32	7,5	25,5	43	0,035
	3080040022	40	5		40	9,5	30	52	0,057
	3080050023	50	5		50	11,5	35	68	0,112
	3080063024	63	1		63	14	41,5	84	0,233
	3080075025	75	1		75	16,5	46,5	100	0,353
	3080090026	90	1		90	19,5	52,5	120	0,571
	3080110027	110	1		110	23,5	60,5	147	0,993
3080125028	125	1		125	27	67	167	1,281	

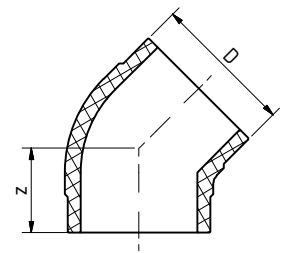
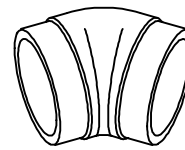

**aquatherm red pipe ELBOW 45° / B1**

SDR	Art. no.	Dimension [mm]	PU m/pc	Price € m/pc	z [mm]	D [mm]	Weight [kg]
					butt welding		
11	3084160003	160	1		95	160	1,463

Advice: Special elbows in diverse degree sizes on request

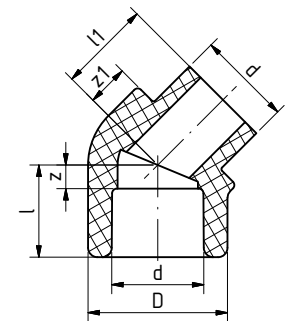
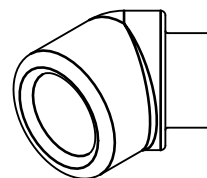

**aquatherm red pipe ELBOW 45° / B1**

female/male

Art. no.	Dimension [mm]	PU m/pc	Price € m/pc	d [mm]	z [mm]	l [mm]	D [mm]	l1 [mm]	z1 [mm]	Weight [kg]
3080032029	32	5		32	7,5	25,5	43	28,5	11,5	0,036
3080040030	40	5		40	9,5	30	52	30,5	13,5	0,059



FITTINGS

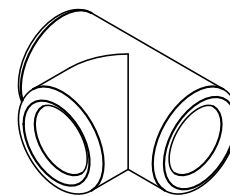
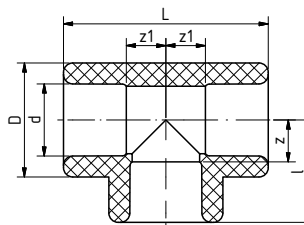

**aquatherm red pipe TEE / B1**

SDR	Art. no.	Dimension [mm]	PU m/pc	Price € m/pc	d [mm]	D [mm]	l [mm]	z [mm]	L [mm]	z1 [mm]	Weight [kg]
socket welding											
7,4	3060025012	25	10		25	34	30,5	14,5	62	15	0,033
	3060032013	32	5		32	43	33,5	15,5	70	17	0,053
	3060040014	40	5		40	52	40,5	20	81	20	0,093
	3060050004	50	5		50	68	49,5	26	99	26	0,200
	3060063005	63	1		63	84	60	32,5	120	32,5	0,377
	3060075006	75	1		75	100	68,5	38,5	137	38,5	0,537
	3060090007	90	1		90	120	80	47	158	46	0,986
	3060110008	110	1		110	147	93	56	186	56	1,632
	3060125009	125	1		125	167	116,5	76,5	233	76,5	2,693

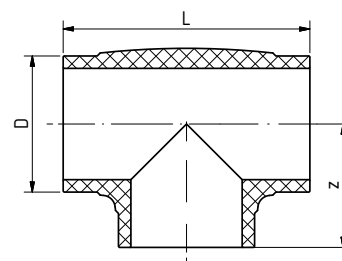
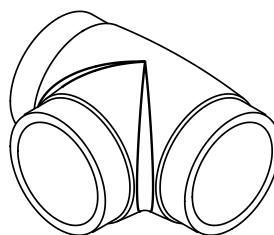

**aquatherm red pipe TEE / B1**

SDR	Art. no.	Dimension [mm]	PU m/pc	Price € m/pc	D [mm]	z [mm]	L [mm]	Weight [kg]
butt welding								
11	3064160004	160	1		160	145	290	2,838

FITTINGS

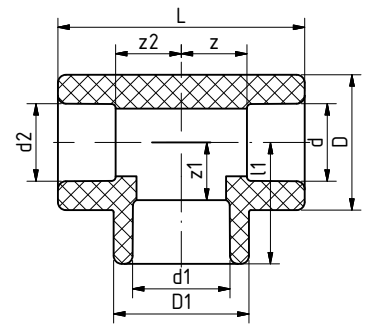
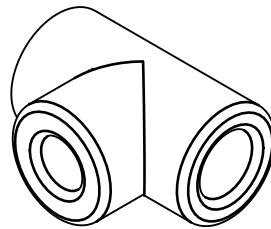

**aquatherm red pipe REDUCING TEE / B1**

SDR	Art. no.	Dimension [mm]	PU m/pc	Price € m/pc	d [mm]	z [mm]	D [mm]	d1 [mm]	l1 [mm]	z1 [mm]	D1 [mm]	d2 [mm]	L [mm]	z2 [mm]	Weight [kg]
					socket welding										
7,4	3060040010	40x32x40	5		40	21,5	52	32	40,5	22,5	52	40	84	21,5	0,106
	3060050011	50x32x50	5		50	26	68	32	44,5	26,5	43	50	99	26	0,174
	3060050012	50x40x50	5		50	26	68	40	49,5	29	68	50	99	26	0,221
	3060063013	63x32x63	1		63	32,5	84	32	53,5	35,5	52	63	120	32,5	0,355
	3060063014	63x40x63	1		63	32,5	84	40	53,5	33	52	63	120	32,5	0,341
	3060063015	63x50x63	1		63	32,5	84	50	60	36,5	68	63	120	32,5	0,411
	3060075016	75x40x75	1		75	38,5	100	40	59	38,5	52	75	137	38,5	0,494
	3060075017	75x50x75	1		75	38,5	100	50	66	42,5	84	75	137	38,5	0,540
	3060075018	75x63x75	1		75	38,5	100	63	66	38,5	84	75	137	38,5	0,507
	3060090019	90x40x90	1		90	46	120	40	66,5	46	52	90	158	46	0,986
	3060090020	90x50x90	1		90	46	120	50	69,5	46	68	90	158	46	0,976
	3060090021	90x63x90	1		90	46	120	63	73,5	46	84	90	158	46	0,969
	3060090022	90x75x90	1		90	46	120	75	76	46	100	90	158	46	0,997
	3060110023	110x63x110	1		110	56	147	63	83,5	56	84	110	186	56	1,691
	3060110024	110x75x110	1		110	56	147	75	86	56	100	110	186	56	1,634
	3060110025	110x90x110	1		110	56	147	90	89	56	120	110	186	56	1,569
	3060125026	125x75x125	1		125	76,5	167	75	106,5	76,5	100	125	233	76,5	2,475
	3060125027	125x90x125	1		125	76,5	167	90	109,5	76,5	120	125	233	76,5	2,542
3060125028	125x110x125	1		125	76,5	167	110	113,5	76,5	147	125	233	76,5	2,606	

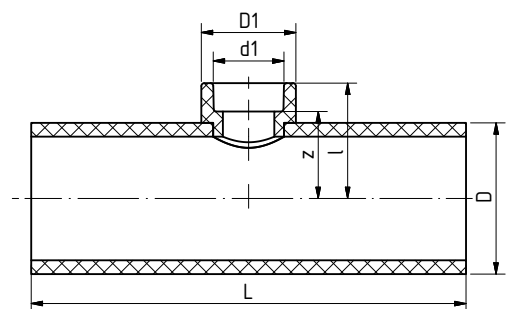
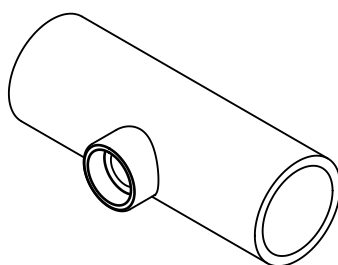

**aquatherm red pipe REDUCING TEE / B1**

SDR	Art. no.	Dimension [mm]	PU m/pc	Price € m/pc	D [mm]	d1 [mm]	D1 [mm]	L [mm]	l [mm]	z [mm]	Weight [kg]
					butt welding						
11	3064160005	160x75x160	1		160	75	100	460	122	92	3,397
	3064160006	160x90x160	1		160	90	120	460	125	92	3,517

FITTINGS

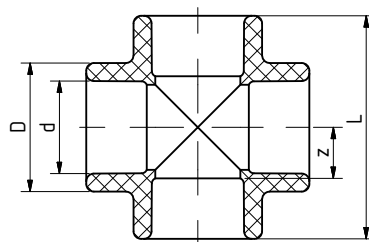
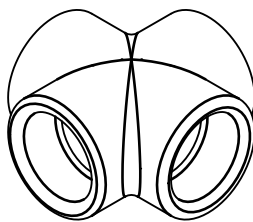

**aquatherm red pipe CROSS / B1**

Art. no.	Dimension [mm]	PU m/pc	Price € m/pc	d [mm]	z [mm]	L [mm]	D [mm]	Weight [kg]
3040032000	32	5		32	17	70	43	0,064
3040040001	40	5		40	21	83	52	0,101

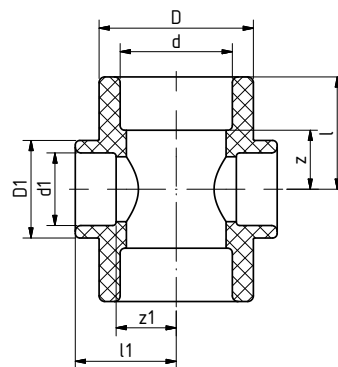
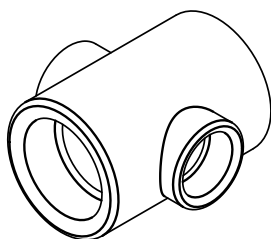

**aquatherm red pipe REDUCING TEE / B1**

Art. no.	Dimension [mm]	PU m/pc	Price € m/pc	d1 [mm]	z1 [mm]	D1 [mm]	l1 [mm]	d [mm]	z [mm]	D [mm]	l [mm]	Weight [kg]
3040050010	50/32	1		32	26,5	43	44,5	50	26	68	49,5	0,180
3040063011	63/32	1		32	35,5	52	53,5	63	32,5	84	60	0,350
3040063012	63/40	1		40	33	52	53,5	63	32,5	84	60	0,328
3040075013	75/32	1		32	41	52	59	75	38,5	100	68,5	0,509
3040075014	75/40	1		40	38,5	52	59	75	38,5	100	68,5	0,499
3040075015	75/50	1		50	42,5	68	66	75	38,5	100	68,5	0,528
3040090016	90/50	1		50	51,5	68	75	90	35,5	120	68,5	0,762

FITTINGS

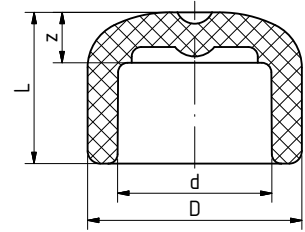
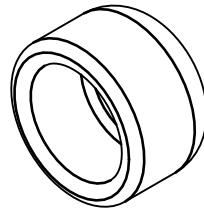

**aquatherm red pipe END CAP / B1**

SDR	Art. no.	Dimension [mm]	PU m/pc	Price € m/pc	d [mm]	L [mm]	z [mm]	D [mm]	Weight [kg]
					socket welding				
7,4	3020025008	25	10		25	24	8	34	0,011
	3020032010	32	5		32	29	11	43	0,044
	3020040012	40	5		40	38	17,5	52	0,042
	3020050014	50	5		50	44,5	21	68	0,082
	3020063016	63	1		63	52	24,5	84	0,153
	3020075018	75	1		75	58,5	28,5	100	0,245
	3020090020	90	1		90	67,5	34,5	120	0,377
	3020110022	110	1		110	65	28	147	0,648
	3020125024	125	1		125	82	42	167	0,872

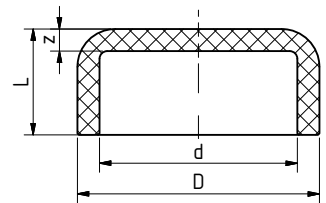
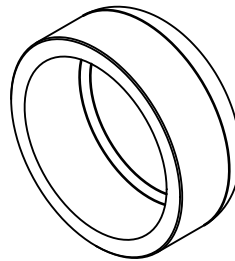

**aquatherm red pipe END CAP / B1**

SDR	Art. no.	Dimension [mm]	PU m/pc	Price € m/pc	D [mm]	L [mm]	z [mm]	d [mm]	Weight [kg]
					butt welding				
11	3024160326	160	1		160	0,00	14,6	131	0,787

FITTINGS

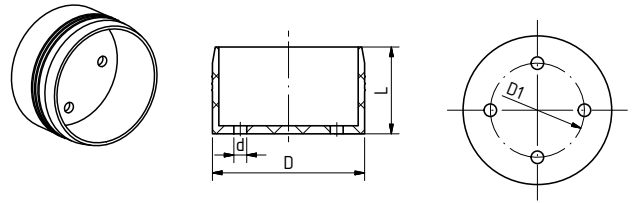

**aquatherm red pipe** BASE PART FOR SPRINKLER OUTLET

Art. no.		PU m/St	Price € m/pc	D [mm]	D1 [mm]	d [mm]	L [mm]	Weight [kg]
3090000001	for visible sprinkler	25		47,35	30	4	27	0,013

**aquatherm red pipe** UPPER PART FOR SPRINKLER OUTLET

for visible sprinkler

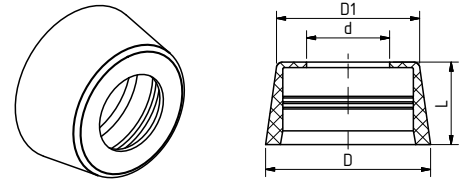

Art. no.	Dimension	PU m/pc	Price € m/pc	D [mm]	D1 [mm]	d [mm]	L [mm]	Weight [kg]
3090000002	1/2"	25		60	51,4	23,2	30,5	0,022
3090000003	3/4"	25		60	51,6	30,2	30	0,022
3090000004	1"	25		60	51,6	35,2	30	0,021

**aquatherm red pipe** BASE PART FOR SPRINKLER OUTLET

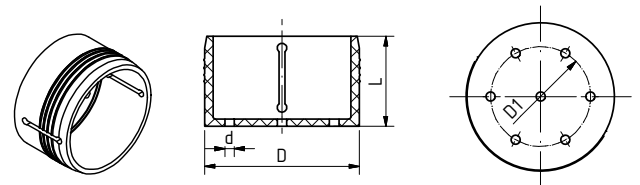

Art. no.		PU m/pc	Price € m/pc	D [mm]	D1 [mm]	d [mm]	L [mm]	Weight [kg]
3090000005	for covered sprinkler	25		65	44	4	38	0,034

**aquatherm red pipe** UPPER PART FOR SPRINKLER OUTLET

for covered sprinkler

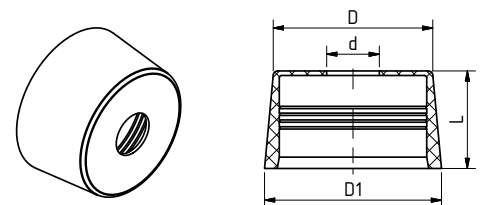

Art. no.	Dimension	PU m/pc	Price € m/pc	D [mm]	D1 [mm]	d [mm]	L [mm]	Weight [kg]
3090000006	1/2"	25		70	78	23,2	43	0,057
3090000007	3/4"	25		70	78	30,2	43	0,057
3090000008	1"	25		70	78	35,2	43	0,056

**aquatherm red pipe** PLUG FOR SPRINKLER OUTLET

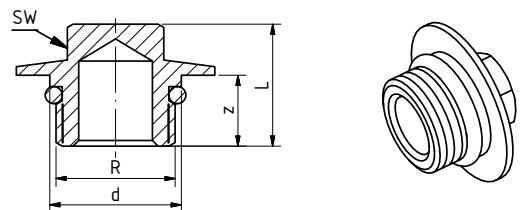

Art. no.	Dimension	PU m/pc	Price € m/pc	R	d [mm]	L [mm]	z [mm]	SW [mm]	Weight [kg]
3050000010	1/2"	25		1/2"	23	21,5	12,5	15	0,043
3050000011	3/4"	25		3/4"	30	23	12,5	17	0,058
3050000013	1"	25		1"	35	24	13	17	0,076

FITTINGS

**aquatherm red pipe** TEMPORARY PLUG FOR PLASTER WORKS

made of PE foam

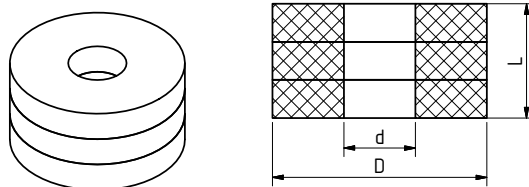

Art. no.	Dimension	PU m/pc	Price € m/pc	d [mm]	D [mm]	L [mm]	Weight [kg]
9704114178	for 3090000002, -03, -04	50		20	60	32	0,003
9704114179	for 3090000006, -07, -08	50		20	75,5	42	0,005

**aquatherm red pipe** SPRINKLER OUTLET

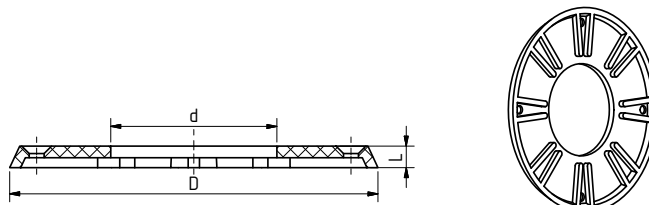

Art. no.	Dimension	PU m/pc	Price € m/pc	D [mm]	d [mm]	L [mm]	Weight [kg]
3090000009	1 1/4"	10		100,1	44,1	6,5	0,028
3090000010	1 1/2"	10		111,1	50,1	6,5	0,034
3090000011	2"	10		126,1	61,1	6,5	0,043

**aquatherm red pipe** PLUG FOR SPRINKLER OUTLET

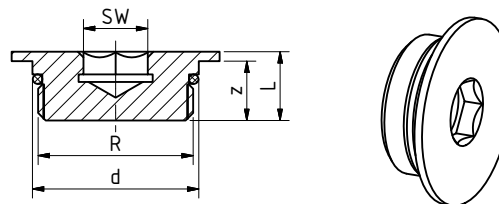

Art. no.	Dimension	PU m/pc	Price € m/pc	d [mm]	R	L [mm]	z [mm]	SW [mm]	Weight [kg]
3050000015	1 1/4"	10		44	1 1/4"	18,2	15,7	17	0,203
3050000016	1 1/2"	10		50	1 1/2"	18	15,5	17	0,260
3050000017	2"	10		61	2"	20	17,5	17	0,443

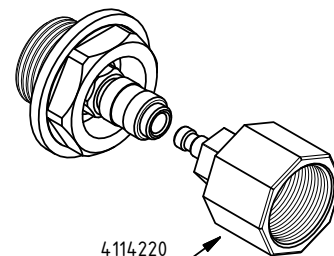
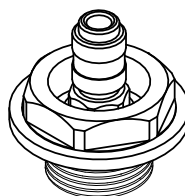
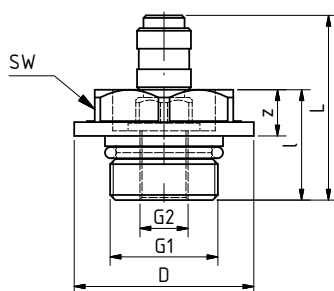

**aquatherm red pipe** PLUG FOR PRESSURE TEST

Art. no.	Dimension	PU m/pc	Price € m/pc	D [mm]	G1	G2	z [mm]	l [mm]	L [mm]	SW [mm]	Weight [kg]
3050000020	1/2"	10		35	1/2"	1/8"	9	21,5	36	27	0,072
3050000021	3/4"	10		35	3/4"	1/8"	9	21,5	36	27	0,093
3050000022	1"	10		40	1"	1/8"	8,5	21,5	36	27	0,126

**aquatherm red pipe** COUPLING PLUG 1/2"

3050000023	1/2" for Art. No. 3050000020, -21, -22	1									0,040
------------	--	---	--	--	--	--	--	--	--	--	-------

FITTINGS

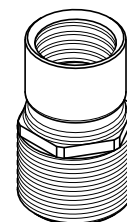
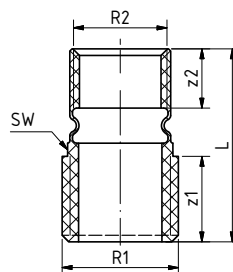

**aquatherm red pipe COMPENSATING JOINT**

Art. no.	Dimension	PU m/pc	Price € m/pc	R1	z1 [mm]	R2	z2 [mm]	L [mm]	SW [mm]	Weight [kg]
9604114230	3/4"mx3/8"f	10		3/4"	17,5	3/8"	15,5	44	24	0,054
9604114232	3/4"mx1/2"f	10		3/4"	19,5	1/2"	13,5	44	24	0,043
9604114234	1"mx1"f	10		1"	17	1"	17	45	36	0,067
9604114236	1"mx1/2"f	10		1"	19,5	1/2"	13,5	44	30	0,052

Without VdS-approval

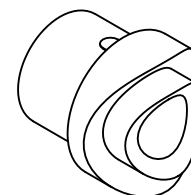
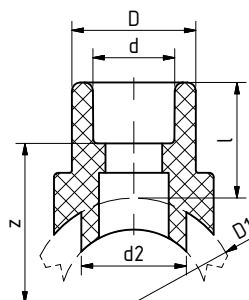

**aquatherm red pipe WELD-IN SADDLE**

SDR	Art. no.	Dimension [mm]	PU m/pc	Price € m/pc	D1 [mm]	d [mm]	d2 [mm]	l [mm]	z [mm]	D [mm]	Weight [kg]
					socket welding						
	3030063001	63/32	5		63	32	32	30	43,5	43	0,028
	3030075002	75/32	5		75	32	32	30	49,5	43	0,028
	3030075003	75/40	5		75	40	40	34	51	52	0,049
	3030090004	90/32	5		90	32	32	30	57	43	0,029
	3030090005	90/40	5		90	40	40	34	58,5	52	0,048
7,4	3030110006	110/32	5		110	32	32	30	67	43	0,030
	3030110007	110/40	5		110	40	40	34	68,5	52	0,050
	3030110008	110/50	5		110	50	50	34	65,5	68	0,030
	3030125009	125/32	5		125	32	32	30	74,5	43	0,029
	3030125010	125/40	5		125	40	40	34	76	52	0,050
	3030125011	125/50	5		125	50	50	34	73	68	0,030
	3030125012	125/63	5		125	63	63	38	73	84	0,154
					butt welding						
11	3030160002	160/63	5		160	63	63	38	0,00	84	0,054
	3034160003	160/75	5		160	75	75	42	92	100	0,248
	3034160004	160/90	5		160	90	90	45	92	120	0,368

With weld-on surface and weld-in socket to be fused with the inner wall of the pipe.

The required tools for the fusion of **aquatherm red pipe** weld-in saddles are listed on page 33:

**aquatherm red pipe** weld-in saddle tools Art. no. 9800050620, 9800050624, 9800050625, 9800050628, 9800050629, 9800050632, 9800050634, 9800050635, 9800050638, 9800050640, 9800050642, 9800050644

**aquatherm** drill Art. no. 9800050942–9800050948

FITTINGS

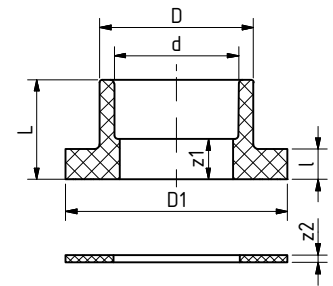
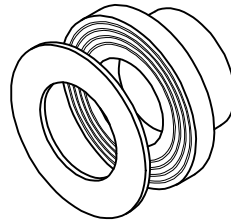

**aquatherm red pipe WELDABLE FLANGE ADAPTER / B1**

with joint ring

SDR	Art. no.	Dimension [mm]	PU m/pc	Price € m/pc	d [mm]	L [mm]	z1 [mm]	D [mm]	D1 [mm]	l [mm]	z2 [mm]	Weight [kg]
					socket welding							
7,4	3050032001	32	1		32	34	16	41	68	10	3	0,053
	3050040002	40	1		40	35,5	15	50	78	11	3	0,071
	3050050003	50	1		50	39,5	17	61	88	12	3	0,095
	3050063004	63	1		63	43,5	16	76	102	14	3	0,130
	3050075005	75	1		75	46	16	90	122	16	3	0,191
	3050090006	90	1		90	50	17	108	138	17	3	0,258
	3050110007	110	1		110	55,5	18,5	131	158	18,5	3	0,329
	3050125008	125	1		125	63	23	165	188	20	3	0,724

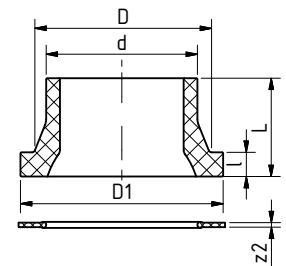
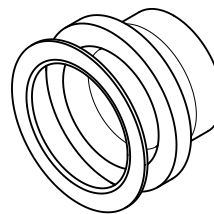

**aquatherm red pipe WELDABLE FLANGE ADAPTER / B1**

with joint ring

SDR	Art. no.	Dimension [mm]	PU m/pc	Price € m/pc	d [mm]	L [mm]	z1 [mm]	D [mm]	D1 [mm]	l [mm]	z2 [mm]	Weight [kg]
					butt welding							
11	3054160009	160	1		160	93	3,00	175	212	25	3	1,065

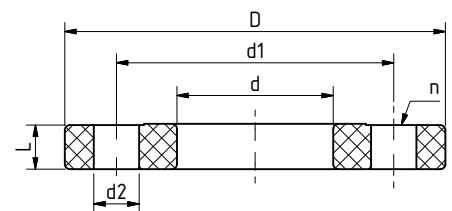
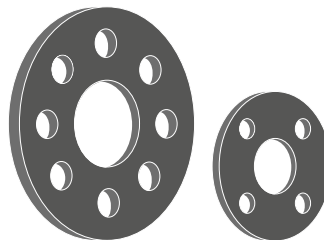

**aquatherm red pipe STEEL FLANGE**

Art. no.	Dimension [mm]	PU m/pc	Price € m/pc	d [mm]	D [mm]	d1 [mm]	d2 [mm]	L [mm]	n	Weight [kg]
9604114200	32	1		42	115	85	14	16	4	1,046
9604114201	40	1		51	140	100	18	16	4	1,589
9604114202	50	0		62	150	110	18	16	4	1,675
9604114206	63	1		78	165	125	18	16	4	2,016
9604114207	75	1		92	185	145	18	16	4	2,437
9604114208	90	1		110	200	160	18	18	8	2,699
9604114212	110	1		133	220	180	18	18	8	3,084
9604114213	125	1		167	250	210	18	18	8	3,654
9604115730	160	1		178	285	240	22	18	8	5,106



**TRANSITION PIECE**

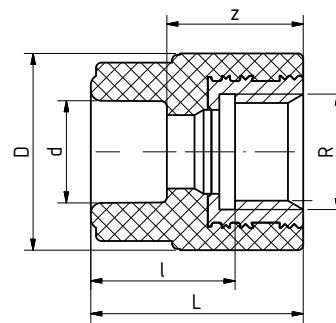
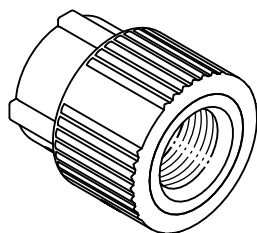

**aquatherm red pipe TRANSITION PIECE / B1**

for the connection to sprinkler outlets  
round

Art. no.	Dimension	PU m/pc	Price € m/pc	d [mm]	l [mm]	z [mm]	D [mm]	L [mm]	R	Weight [kg]
3070025020	25mm x 1/2" f	10		25	29,5	26,5	38,5	42,5	1/2"	0,065
3070025021	25mm x 3/4" f	10		25	27,5	24,5	43,5	40,5	3/4"	0,087
3070032022	32 mm x 3/4" f	5		32	30,5	25,5	43,5	43,5	3/4"	0,092
3070032023	32 mm x 1/2" f	5		32	30	25	37,5	43	1/2"	0,076
3070040024	40 mm x 1/2" f	5		40	32,5	25	37,5	45,5	1/2"	0,078
3070040025	40 mm x 3/4" f	5		40	33	25,5	50	46	3/4"	0,105

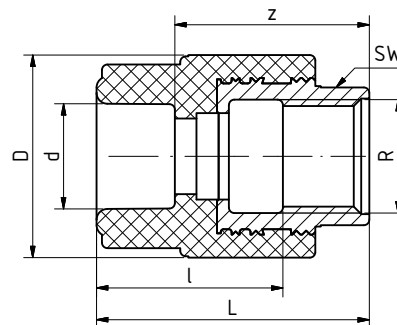
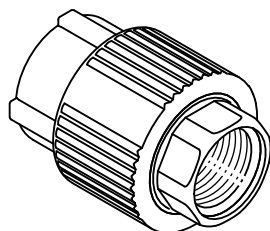

**aquatherm red pipe TRANSITION PIECE / B1**

with hexagon (\*suitable for the connection to sprinkler outlets)

Art. no.	Dimension	PU m/pc	Price € m/pc	d [mm]	l [mm]	z [mm]	D [mm]	L [mm]	R	SW [mm]	Weight [kg]
3070032026	32 mm x 3/4" f	5		32	32	35	43,5	53	3/4"	31	0,104
3070032027 *	32 mm x 1" f	5		32	37,5	41,5	60	59,5	1"	39	0,239
3070040028 *	40 mm x 1" f	5		40	40	41,5	60	62	1"	39	0,227
3070040029	40 mm x 1 1/4" f	5		40	40	42,5	74	63	1 1/4"	50	0,385
3070050030	50 mm x 1 1/4" f	5		50	43	42,5	74	66	1 1/4"	50	0,404
3070050031	50 mm x 1 1/2" f	5		50	45	43,5	85,5	67	1 1/2"	55	0,445
3070063032	63 mm x 1 1/2" f	1		63	51,5	46	84	73,5	1 1/2"	55	0,479
3070063033	63 mm x 2" f	1		63	50	49,5	101	76	2"	67	0,662
3070075034	75 mm x 2" f	1		75	51	47	100	77	2"	67	0,671
3070032035	32 mm x 1/2" f	5		32	37	35	37,5	53	1/2"	24	0,091
3070040036	40 mm x 1/2" f	5		40	38	33,5	40	54	1/2"	24	0,094

TRANSITION PIECE

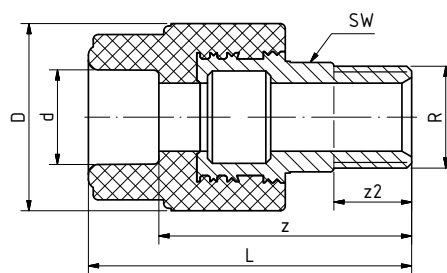
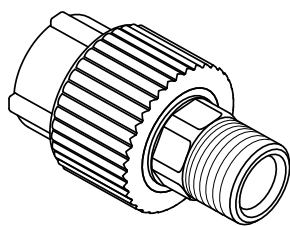

**aquatherm red pipe** TRANSITION PIECE / B1

with hexagon

Art. no.	Dimension	PU m/pc	Price € m/pc	d [mm]	L [mm]	z [mm]	D [mm]	R	SW [mm]	z2 [mm]	Weight [kg]
3070032037	32 mm x 3/4" m	5		32	69,5	51,5	38,5	3/4"	24	17	0,135
3070032038	32 mm x 1" m	5		32	78,5	60,5	53	1"	32	20	0,244
3070032039	32 mm x 1 1/4" m	5		32	81	63	68	1 1/4"	41	21	0,324
3070040040	40 mm x 1" m	5		40	81	60,5	52	1"	32	20	0,251
3070040041	40 mm x 1 1/4" m	5		40	84,5	64	68	1 1/4"	41	21	0,362
3070050042	50 mm x 1 1/4" m	5		50	85,5	62	68	1 1/4"	41	21	0,389
3070050043	50 mm x 1 1/2" m	5		50	88,5	65	74	1 1/2"	46	22	0,480
3070063044	63 mm x 1 1/2" m	1		63	94,5	67	72,5	1 1/2"	46	22	0,523
3070063045	63 mm x 2" m	1		63	102,5	75	84	2"	50	23,5	0,708
3070075046	75 mm x 2" m	1		75	102	72	84	2"	50	23,5	0,753
3070075047	75 mm x 2 1/2" m	1		75	105	75	100	2 1/2"	65	26,7	1,024
3070090048	90 mm x 3" m	1		90	121	88	120	3"	85	30	1,488
3070110049	110 mm x 4" m	1		110	148	111	147	4"	105	39	2,816

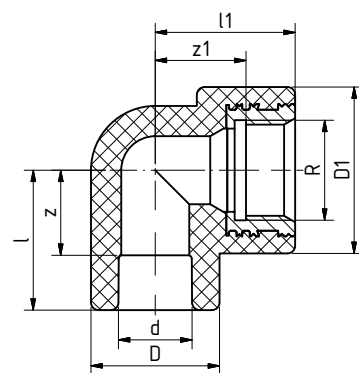
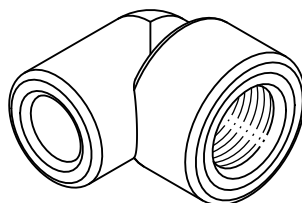

**aquatherm red pipe** TRANSITION ELBOW / B1

Art. no.	Dimension	PU m/pc	Price € m/pc	d [mm]	l [mm]	z [mm]	D [mm]	l1 [mm]	z1 [mm]	D1 [mm]	R	Weight [kg]
3070032001	32 mm x 1/2" f	10		32	35	17	43	37	24	37	1/2"	0,088
3070032003	32 mm x 3/4" f	5		32	27,5	9,5	43	51	38	44	3/4"	0,112
3070032004	32 mm x 1" f	5		32	34	16	43	66,5	44,5	60,5	1"	0,265
3070040004	40 mm x 1/2" f	5		40	41,75	21,25	52	40	27	37	1/2"	0,116
3070040005	40 mm x 1" f	5		40	41,5	21	52	56	34	60	1"	0,265

TRANSITION PIECE

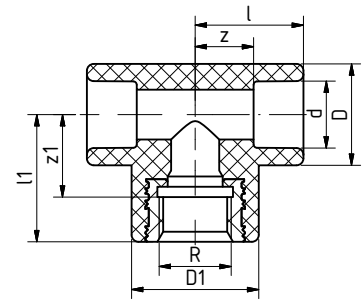
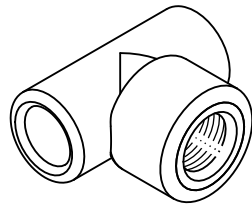

**aquatherm red pipe** THREADED BRANCH TEE / B1

Art. no.	Dimension	PU m/pc	Price € m/pc	d [mm]	l [mm]	z [mm]	D [mm]	l1 [mm]	z1 [mm]	D1 [mm]	R	SW [mm]	Weight [kg]
3060025030	25 x 1/2" f x 25 mm	10		25	34,5	18,5	34	38	25	37	1/2"	-	0,088
3060032031	32 x 1/2" f x 32 mm	5		32	35	17	43	37	24	37	1/2"	-	0,113
3060032032	32 x 3/4" f x 32 mm	5		32	27,5	9,5	43	51	38	44	3/4"	-	0,118
3060032033	32 x 1" f x 32 mm	5		32	31,5	13,5	43	67	45	60	1"	39	0,274
3060040034	40 x 1/2" f x 40 mm	5		40	42	21,5	52	40	27	37	1/2"	-	0,113
3060040035	40 x 3/4" f x 40 mm	5		40	40,5	20	52	40,5	27,5	52	3/4"	-	0,157
3060040036	40 x 1" f x 40 mm	5		40	41,5	21	52	56	34	60	1"	39	0,279
3060050037	50 x 1" f x 50 mm	5		50	49,5	26	68	63,5	41,5	68,3	1"	39	0,387
3060050038	50 x 1 1/4" f x 50 mm	5		50	49,5	26	68	66,5	47,5	68	1 1/4"	50	0,478
3060050040	50 x 1/2" f x 50 mm	5		50	49,5	26	68	44,5	31,5	43	1/2"	-	0,237
3060050041	50 x 3/4" f x 50 mm	5		50	49,5	26	68	44,5	31,5	43	3/4"	-	0,243

TRANSITION PIECE

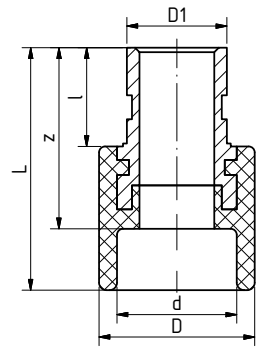
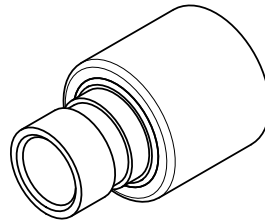

**aquatherm red pipe** TRANSITION PIECE FOR GROOVE CONNECTION / B1

Art. no.	Dimension	PU m/pc	Price € m/pc	d [mm]	L [mm]	l [mm]	z [mm]	D [mm]	D1 [mm]	DN	Weight [kg]
3070040010	40/1"	5		40,00	81,00	33	60,50	52,00	33,50	25	0,230
3070050011	50/1 1/4"	5		50,00	85,50	36	62,00	68,00	42,20	32	0,375
3070063012	63/1 1/2"	1		63,00	97,50	39	70,00	84,00	48,25	40	0,536
3070075013	75/2"	1		75,00	97,00	39	67,00	100,00	60,30	50	0,788
3070090014	90/3"	1		88,50	110,00	39	77,00	120,00	88,90	65	1,278
3070110015	110/4"	1		108,30	119,50	40,5	82,50	147,00	114,30	80	2,164
3070125016	125/5"	1		125,00	170,00	75	130,00	167,00	140,00	90	5,030

**TRANSITION PIECE**

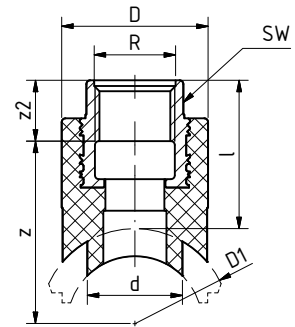
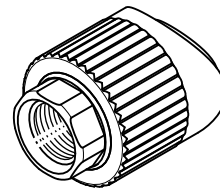

**aquatherm red pipe WELD-IN SADDLE WITH FEMALE THREAD / B1**

Art. no.	Dimension	PU m/pc	Price € m/pc	D1 [mm]	d [mm]	l [mm]	z [mm]	z2 [mm]	D [mm]	R	SW [mm]	Weight [kg]
3030040021	40/25 mm x 1/2" f	5		40	25	39	43	16	38,5	1/2"	24	0,088
3030050022	50/25 mm x 1/2" f	5		50	25	39	48	16	38,5	1/2"	24	0,090
3030063002	63/25mm x 1/2" f	5		63	25	39	54,5	16	38,5	1/2"	24	0,089
3030075001	75/25mm x 1/2" f	5		75	25	39	60,5	16	38,5	1/2"	24	0,097
3030075023 *	75/32 mm x 1" f	5		75	32	43	58,5	22	60	1"	39	0,221
3030090024 *	90/32 mm x 1" f	5		90	32	43	66	22	60	1"	39	0,222
3030110025 *	110/32 mm x 1" f	5		110	32	43	76	22	60	1"	39	0,088
3030125026 *	125/32 mm x 1" f	5		125	32	43	93,5	22	60	1"	39	0,091

with female thread and hexagon socket, with weld-in weld-on surface and weld-in socket to be fused with the inner wall of the pipe  
 The required tools for the fusion of **aquatherm red pipe** weld-in saddles are listed on page 33:

- Weld-in saddle tools, Art. no. 9800050614 – 9800050644
- **aquatherm** drill, Art. no. 9800050940 – 9800050948
- \*suitable for the connection to sprinkler outlets

**CUTTER & WELDING DEVICES**

**aquatherm PIPE CUTTER**

Art. no.	for pipe dimensions	PU m/pc	Price € m/pc
9800050102	ø 16–40 mm	1	
9800050105	ø 50–125 mm	1	
9800050106	ø 110–160 mm	1	

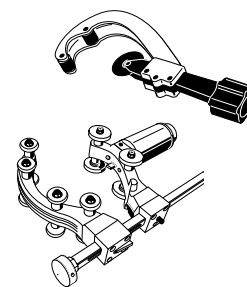

**aquatherm PIPE CUTTER**

Art. no.	for pipe dimensions	PU m/pc	Price € m/pc
9800050104	ø 16–40 mm	1	

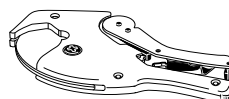

**Important:** Do not cut the aquatherm red pipe pipes with customary hack saws. aquatherm red pipe pipes can be cut with customary saws equipped with saw blades suitable for plastic.

**ORBITAL CIRCULAR SAW**

Art. no.	for pipe dimensions	PU m/pc	Price € m/pc
9800050108	ø 160–355 mm	1	

This orbital circular saw can be ordered directly from Rothenberger with Art. no. 9800050108 ([www.rothenberger.com](http://www.rothenberger.com)). High-performance orbital circular saw for fast, precise, perfectly aligned and right-angled cutting of plastic pipes 160–355 mm at the building site or in the workshop.

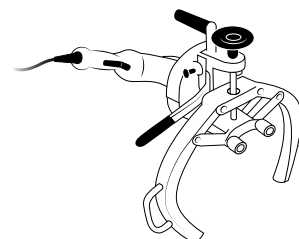

**CUTTING DISC FOR PLASTIC**

Art. no.	Dimension	Borehole	PU m/pc	Price € m/pc
9800050107	ø 125 mm	22,2 mm	1	
9800050109	ø 230 mm	22,2 mm	1	

Application: for each angle grinder  
Design: diamond galvanized cutting disc

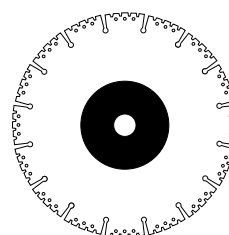

**aquatherm MANUAL WELDING DEVICE (500 W)**

Art. no.	for pipe dimensions	PU m/pc	Price € m/pc
9800050336	ø 16–32 mm	1	

With base and case for tools

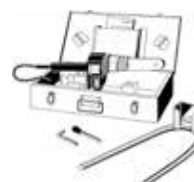

**aquatherm MANUAL WELDING DEVICE (800 W)**

Art. no.	for pipe dimensions	PU m/pc	Price € m/pc
9800050337	ø 16–63 mm	1	

With base and case for tools

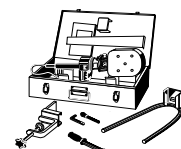

**CUTTER & WELDING DEVICES**

**aquatherm MANUAL WELDING DEVICE (1400 W)**

Art. no.	for pipe dimensions	PU m/pc	Price € m/pc
9800050341	ø 50–125 mm	1	

With base and case for tools

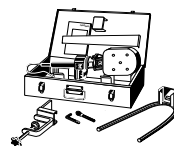

**aquatherm WELDING MACHINE (1400 W)**

Art. no.	for pipe dimensions	PU m/pc	Price € m/pc
9800050148	ø 50–125 mm	1	

incl. welding tools 50–125 mm, roll stand and wooden transport case

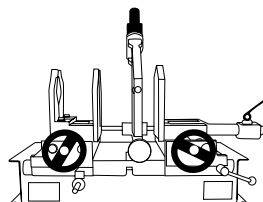

**aquatherm ELECTRIC WELDING JIG**

Art. no.	for pipe dimensions	PU m/pc	Price € m/pc
9800050161	ø 63–125 mm	1	

incl. spare battery, charging station and metal case Support: Art. no. 9800050151 on request

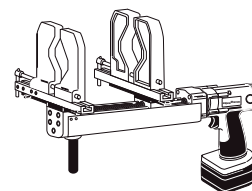

**aquatherm BASE FOR ART. NO. 9800050151**

Art. no.	Dimension	PU m/pc	Price € m/pc
9800050151		1	

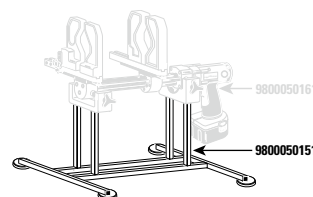

**aquatherm WELDING MACHINE (1400 W) LIGHT**

Art. no.	for pipe dimensions	PU m/pc	Price € m/pc
9800050145	ø 63–125 mm	1	

aquatherm manual welding device (1400 W) and wooden transport case

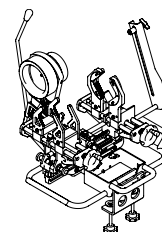

**BUTT WELDING MACHINE WIDOS**

Art. no.	Dimension	PU m/pc	Price € m/pc
9800050352*	ø 160–250 mm	1	

The butt-welding-machine can be purchased directly from Widos ([www.widos.de](http://www.widos.de))

\* Also available in design with 110 volt (Art. no. 9800450352 = ø 160–250 mm / 9800450353 = ø 160–315 mm / 9800450354 = ø 160–315 mm / 9800450354 = ø 160–355 mm / 9800450355 = ø 200–450 mm)

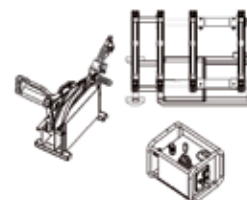

**BUTT WELDING MACHINE RITMO**

Art. no.	for pipe dimensions	PU m/pc	Price € m/pc
9800050165	ø 160–250 mm	1	

incl. wooden transport box.

The butt welding machine can be obtained directly from Ritmo ([www.ritmo.it](http://www.ritmo.it)).

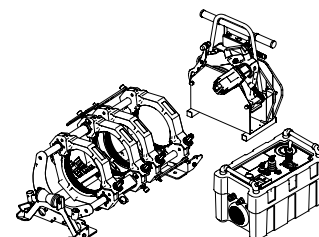

WELDING TOOLS & DRILLS

**aquatherm TEMPERATURE MEASURING DEVICE**

Art. no.	Dimension	PU m/pc	Price € m/pc
9800050188		1	

to check the correct welding temperature



**aquatherm THERMOCOLOUR PENCIL**

Art. no.	Dimension	PU m/pc	Price € m/pc
9800050190		1	

to check the correct welding temperature

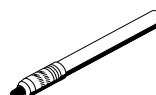

**aquatherm CLEANING WIPES**

Art. no.	Dimension	PU m/pc	Price € m/pc
9800050193	Box with 100 towels	1	

for electrofusion sockets



**aquatherm WELDING TOOL**

Art. no.	Dimension [mm]	PU m/pc	Price € m/pc
9800050210	25	1	
9800050212	32	1	
9800050214	40	1	
9800050216	50	1	
9800050218	63	1	
9800050220	75	1	
9800050222	90	1	
9800050224	110	1	
9800050226	125	1	

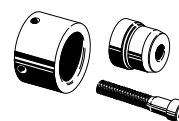

**aquatherm REPAIR KIT**

Art. no.	Dimension	PU m/pc	Price € m/pc
9800050307	7 mm	1	
9800050311	11 mm	1	

to close pipe holes up to 10 mm (pipe repair stick Art. no. 3090000012)



**aquatherm red pipe REPAIR STICK**

Art. no.	Dimension	PU m/pc	Price € m/pc
3090000012	7/11 mm	1	

Material: **Fusiole**n® PP-R FS to close pipe holes up to 10 mm.  
Tool: **aquatherm green pipe** repair kit (Art. no. 9800050307 + 9800050311).

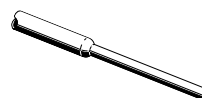



## WELDING TOOLS & DRILLS

### aquatherm WELDING TOOL

for welding saddles of Art. no. 3030063001 – 3030125012 and 3030040021 – 3030125026

Art. no.	Dimension	PU m/pc	Price € m/pc
9800050614	40 x 20/25 mm	1	
9800050616	50 x 20/25 mm	1	
9800050619	63 x 20/25 mm	1	
9800050620	63 x 32 mm	1	
9800050623	75 x 20/25 mm	1	
9800050624	75 x 32 mm	1	
9800050625	75 x 40 mm	1	
9800050628	90 x 32 mm	1	
9800050629	90 x 40 mm	1	
9800050632	110 x 32 mm	1	
9800050634	110 x 40 mm	1	
9800050635	110 x 50 mm	1	
9800050638	125 x 32 mm	1	
9800050640	125 x 40 mm	1	
9800050642	125 x 50 mm	1	
9800050644	125 x 63 mm	1	
9800050648	160 x 20/25 mm	1	
9800050650	160 x 32 mm	1	
9800050652	160 x 40 mm	1	
9800050654	160 x 50 mm	1	
9800050656	160 x 63 mm	1	
9800050657	160 x 75 mm	1	
9800050658	160 x 90 mm	1	

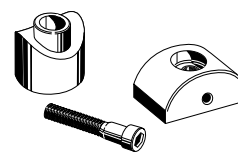

### aquatherm DRILL

for installation of weld-in saddles

Art. no.	Dimension	PU m/pc	Price € m/pc
9800050940	20 & 25 mm (for pipes 40–160 mm)	1	
9800050942	32 mm	1	
9800050944	40 mm	1	
9800050946*	50 mm	1	
9800050948*	63 mm	1	
9800050987*	75 mm	1	
9800050988*	90 mm	1	

\* may only be used in fixed drilling machines

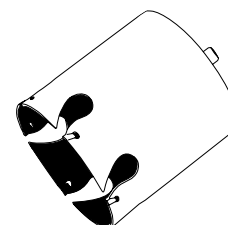
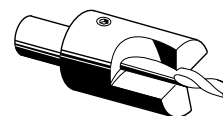

### QUICK CHANGE ADAPTER 75 – 90MM

Art. no.	Dimension	PU	Box unit	Price € pc
9800050973	for Art. no. 9800050987 – 9800050988	1		

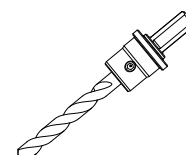

PRODUCTS

**aquatherm red pipe EXTRACTION TOOL**

for sprinkler outlet Art. no. 3090000002-08

Art. no.	Dimension	PU m/pc	Price € m/pc
9800050290		1	

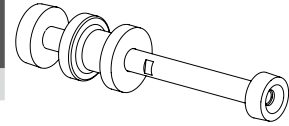

**aquatherm red pipe ADJUSTING TOOL**

for compensating joint  
with adapter 3/8" male, 1/2" male, 1" male

Art. no.	Dimension	PU m/pc	Price € m/pc
9800050291		1	

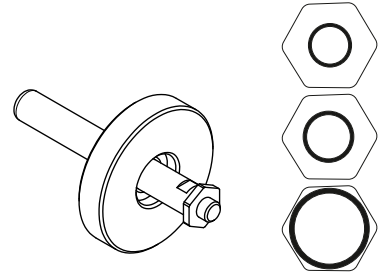

**PART A:****Mounting of the welding tools****1. Important!**

Only use original aquatherm welding devices and aquatherm welding tools.

2. Assemble and tighten the cold welding tools manually.
3. All welding tools must be free from impurities. Check, if they are clean before assembling. If necessary, clean the welding tools with a non-fibrous, coarse tissue and with spirit.
4. Place the welding tools, so that there is full surface contact between the welding tool and the welding plate. Welding tools over  $\varnothing$  40 mm must always be fitted to the rear position of the welding plate.
5. Plug in the welding device and check, if operating lamp is on. Depending on the ambient temperature it takes 10–30 minutes to heat-up the welding plate.

**The heat-up phase ends, when the temperature pilot lamp blinks and a signal is audible.**

**Electric power supply:**

The power supply must coincide with the data on the type plate of the welding device and must be protected according to the local regulations. To avoid high power loss, the conductor cross-section of the used extension cables must be selected according to the power input of the welding devices.



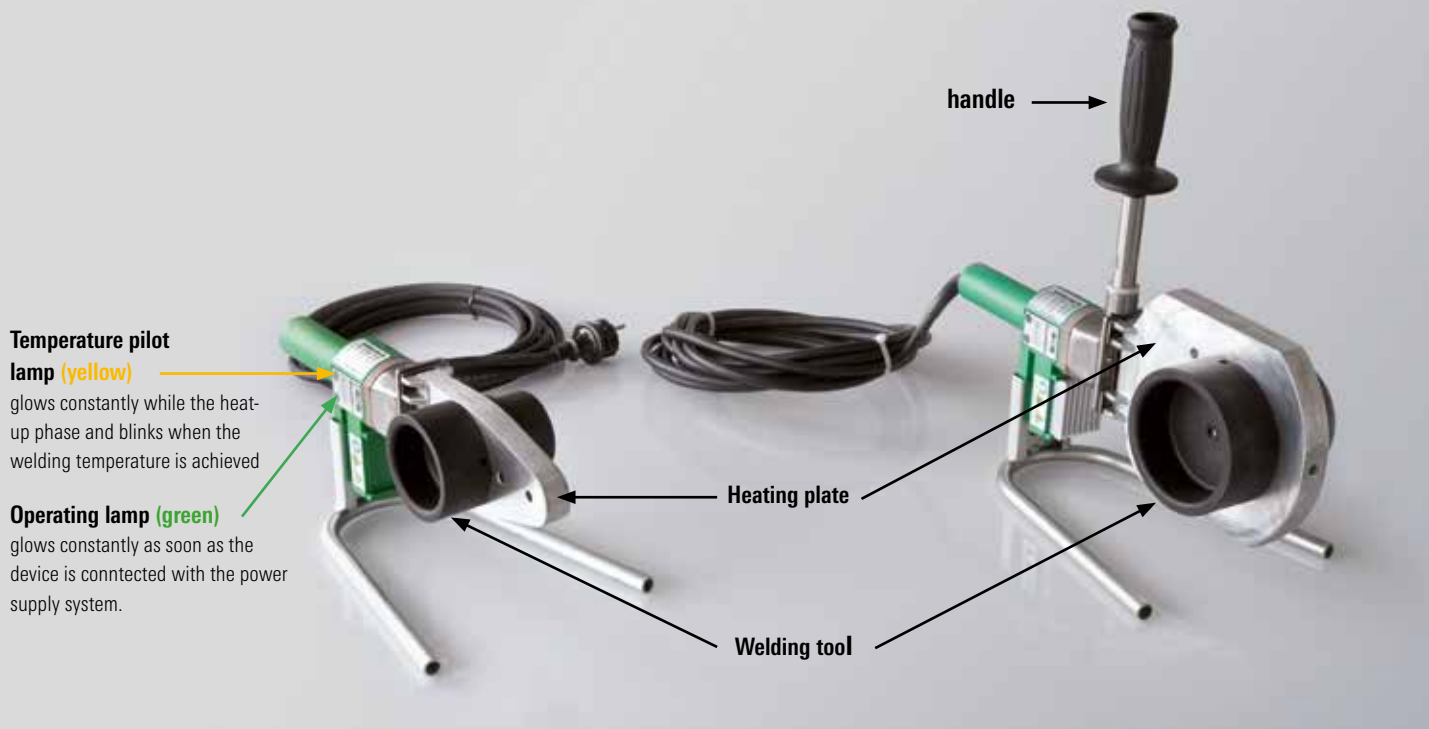

**Temperature pilot lamp (yellow)**  
glows constantly while the heat-up phase and blinks when the welding temperature is achieved

**Operating lamp (green)**  
glows constantly as soon as the device is connected with the power supply system.

handle →

Heating plate

Welding tool

**PART A:  
Heat-up phase**

- 6. During the heat-up phase tighten the welding tools carefully with the Allen Key. Take care that the tools fully contact the welding plate. Never use pliers or any other unsuitable tools, as this will damage the coating of the welding tools.
- 7. The required temperature to weld the aquatherm red pipe system is 260 °C. Acc. to DVS-Welding Guidelines, the temperature of the welding device has to be checked at its tool before starting the welding process. This has to be done with a fast indicating thermometer or alternatively with an aquatherm green pipe thermocolour crayon. (see "Fusion part B, item 2")

**ATTENTION:**

First welding at the earliest 10 minutes after reaching the welding temperature DVS 2207, Part 11.

**PART A:  
Handling**

- 11. Protect aquatherm welding devices and tools against impurities. Burnt-in particles may result in an incorrect fusion. The tools may be cleaned with aquatherm cleaning wipes, Art. no. 9800050193. Always keep the burnt-in welding tools dry. If necessary, dry them with a clean, non-fibrous tissue.
- 12. For perfect fusion, damaged or dirty welding tools must be replaced, as only undamaged tools ensure a perfect fusion welding.
- 13. Never attempt to open or repair a defective device. Return the defective device for repair.
- 14. Check the operating temperature of the aquatherm green pipe welding devices regularly by means of suitable measuring instruments.

- 8. A tool change on a heated device requires another check of the welding temperature at the new tool (after heat-up phase).
- 9. If the device has been unplugged, i. e. during longer breaks, the heat-up process has to be restarted (from item 5).
- 10. After use unplug the welding device and cool down. Water must never be used to cool the welding device, as this would destroy the heating resistances.

**PART A:  
Guidelines**

- 15. For the correct handling of welding machines the following must be observed:  
  
General Regulations for Protection of Labour and Prevention of Accidents  
  
and particularly  
  
the Regulations of the Employers' Liability Insurance Association of the Chemical Industry regarding Machines for the Processing of Plastics, chapter: „Welding Machines and Welding Equipment“.
- 16. For the handling of the aquatherm welding machines, devices and tools please observe  
  
General Regulations DVS 2208 Part 1 of the German Association for Welding Engineering, Registered Society (Deutscher Verband für Schweißtechnik e. V.).

**PART B:****Checking of devices and tools**

1. Check, if the aquatherm welding device and tool correspond to the guidelines "Fusion Part A".
2. All devices and tools in use must have reached the required operating temperature of 260 °C in use. This needs a separate, compulsory test, acc. to DVS-Welding Guideline. The control of the operating temperature can be made with fast indicating thermometers.

Suitable measuring instruments must offer a temperature measurement of up to 350 °C with a high accuracy.

Alternatively it is also possible to check the welding temperature with the aquatherm thermocolour crayon. The application of the special thermo-colour chalk in the aluminium crayon enables an exact reading with a tolerance of +/- 5 K to heated surfaces.

**Application:**

After the temperature pilot lamp of the welding device has indicated the end of the heat-up period, put a firm chalk line on the heated external surface of the welding tool. The colour must change within 1–2 seconds.

If the temperature is too high, the colour will change immediately and if it is too low (below 260 °C) it will change after 3 or more seconds.

**If the colour does not change within 1–2 seconds, another temperature test has to be carried out, respectively the control of the welding device is required.**



Measurement of temperature at the aquatherm manual welding device (800 W)



Temperature control aquatherm welding device (1400 W)



Temperature control aquatherm welding machine



Temperature control with the aquatherm thermocolour crayon



Measurement of temperature at the aquatherm butt-welding machine

**PART B:**

**Preparation for the fusion**

- Cut the pipe right-angled to the pipe axis.

Only use aquatherm green pipe pipe cutters or other suitable cutting tools. Take care that the pipe is free from burrs or cutting chips and remove if necessary.

- Mark the welding depth at the end of the pipe with the enclosed pencil and template.
- Mark the desired position of the fitting on the pipe and/or fitting.

The auxiliary markings on the fitting and the continued line on the pipe may be used as a help.

**The fusion is subject to the following data**

Pipe external-Ø	Welding depth	Heat-up time	Welding time	Cooling time
mm	mm	sec. DVS	sec	min
25	16,0	7	4	2
32	18,0	8	6	4
40	20,5	12	6	4
50	23,5	18	6	4
63	27,5	24	8	6
75	30,0	30	8	8
90	33,0	40	8	8
110	37,0	50	10	8
125	40,0	60	10	8

**The General Guidelines for Heated Socket Welding acc. to DVS 2207 Part 11 apply.**



Cutting of the pipe



Marking of the welding depth



Warming

Joining, fixing and...

...aligning!

## PART B: Heat-up of pipe and fittings

6. Push the end of the pipe, without turning, up to the marked welding depth into the welding tool and at the same time the fitting, without turning, as far as it will go on the tool. It is essential to observe the above mentioned heating times.

Pipes and fittings of the dimensions  $\varnothing$  75 to 125 mm may only be welded with welding device Art. no. 9800050341 (or with machine Art. no. 9800050148). On using the aquatherm green pipe welding machine Art. no. 9800050148, a separate operating instruction has to be observed.

### ATTENTION:

The heating time starts, when pipe and fitting have been pushed with the correct welding depth on and in the welding tool. Not before!

7. After the stipulated heat-up time quickly remove pipe and fitting from the welding tools. Join them immediately, without turning, until the mark welding depth is covered by PP-bead of the fitting.

## PART B: Setting and alignment

### ATTENTION:

**Do not push the pipe too far into the fitting, as this would reduce the bore and in an extreme case may close the pipe.**

8. The joint elements have to be fixed during the specified processing time. Use this time to correct the connection. Correction is restricted to the alignment of pipe and fitting. Never turn the elements or align the connection after the processing time.
9. After the cooling period the fused joint is ready for use.

**The result of the fusion of pipe and fitting is a permanent material joining of the system elements.**

**Unrivalled connection technique with security for a life-time!**

## VISUAL INSPECTION OF FUSION SEAM

Normally on fusioning a bead is formed around the entire circumference at the edge of the socket. This bead is an indication of proper welding.

Incorrect shape of bead

**1**

Different shape of bead (b) or non-existent bead at one or at both ends (a) (partial or total extent), resulting from:

- Temperature of heating tool is too low (a)
- Heat-up time too short (a)
- Unacceptable tolerances (a and b)
- Excessive temperature of heating tool (b)
- Heat-up time too long (b)

**2**

Single shape of bead, resulting from:

- Heat-up time too short
- Temperature of heating tool is too low
- Unacceptable tolerances
- Heat-up of only one welding part

**3**

Excessive melting, resulting from:

- Temperature of heating tool is too high
- Misaligned movement of welding-part, e.g. by inadequate fixing
- Unacceptable tolerances

**4**

Elbow variance

Partially or double-sided inclined welded pipe into the socket without or with slight bracing, resulting from:

- Machinery defect
- False installation

Acceptable, if  $e \leq 2 \text{ mm}$

**5**

Mistake of bonding by improper pipe insertion, resulting from:

- Heat-up time too short
- Pipe ends not at 90° (right-angled)
- Heating temperature too low
- Axial movement during cooling time
- Change-over time too long

Acceptable up to  $0.1 \times d$  and  $0.15 \times$  socket depth



**VISUAL INSPECTION OF FUSION SEAM**

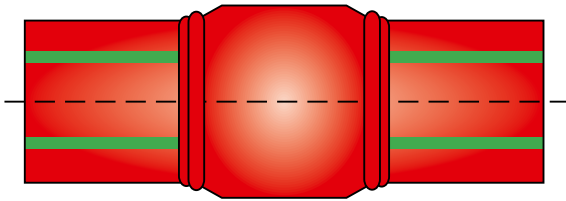

correct fusion welding

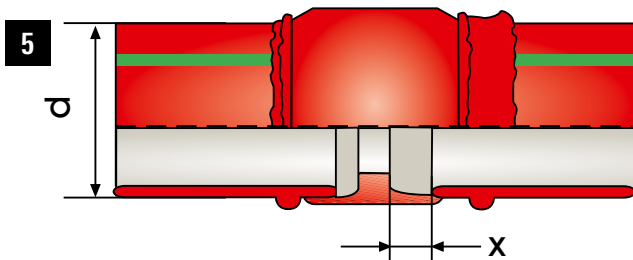
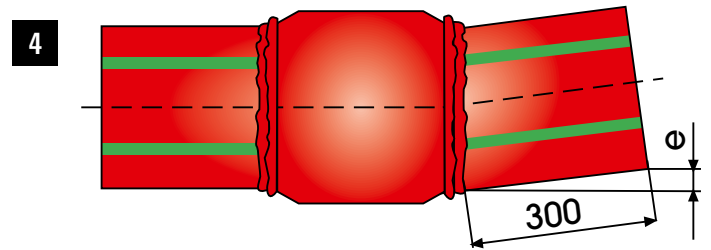
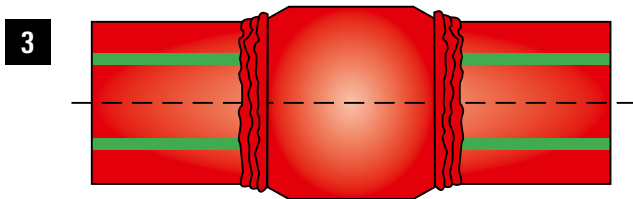
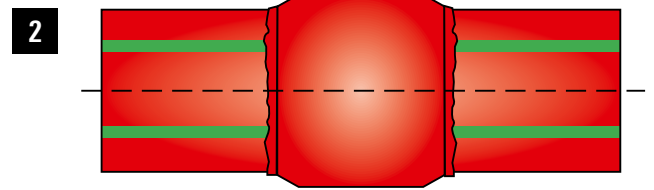
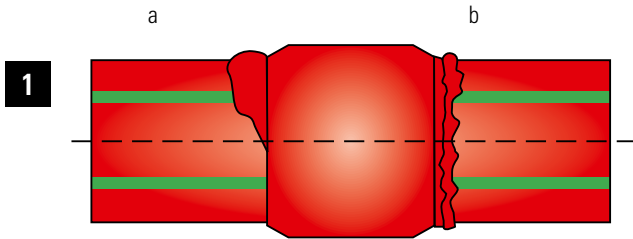

The visual inspection may be only a first indication of the welding seam quality.

But it is not a replacement for the leak test, which has to be carried out after the completion of the installation.

Source:  
DVS 2202-1, to purchase at DVS-publisher, Düsseldorf Copyright Publisher for fusion and related procedures DVS-Verlag GmbH

**PART C:**

**Weld-in saddles**

For pipe external diameters of 63, 75, 90, 110, 125, 160 mm

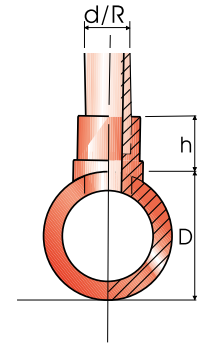

Art. no.	Dimension	D	d	R	h	Sensorwells	Drill	Welding Tool
		mm	mm	f	mm	ø mm	Art. no.	Art. no.
3030063001	63/32 mm	63	32	-	30,0	-	9800050942	9800050620
3030075002	75/32 mm	75	32	-	30,0	-	9800050942	9800050624
3030075003	75/40 mm	75	40	-	34,0	-	9800050944	9800050625
3030090004	90/32 mm	90	32	-	30,0	-	9800050942	9800050628
3030090005	90/40 mm	90	40	-	34,0	-	9800050944	9800050629
3030110006	110/32 mm	110	32	-	30,0	-	9800050942	9800050632
3030110007	110/40 mm	110	40	-	34,0	-	9800050944	9800050634
3030110008	110/50 mm	110	50	-	34,0	-	9800050946	9800050635
3030125009	125/32 mm	125	32	-	30,0	-	9800050942	9800050638
3030125010	125/40 mm	125	40	-	34,0	-	9800050944	9800050640
3030125011	125/50 mm	125	50	-	34,0	-	9800050946	9800050642
3030125012	125/63 mm	125	63	-	38,0	-	9800050948	9800050644
3034160003	160/75 mm	160	75	-	42,0	-	9800050940	9800050657
3034160004	160/90 mm	160	90	-	45,0	-	9800050940	9800050658
3030040021	40/25x1/2" f.	40		1/2"	39,0	14	9800050940	9800050614
3030050022	50/25x1/2" f.	50		1/2"	39,0	14	9800050940	9800050616
3030063002	63/25 x 1/2" f.	63		1/2"	39,0	14	9800050940	9800050619
3030075001	75/25 x 1/2" f.	75		1/2"	39,0	14	9800050940	9800050623
3030075023	75/32x1" f.	75		1"	43,0	20	9800050942	9800050624
3030090024	90/32x1" f.	90		1"	43,0	20	9800050942	9800050628
3030110025	110/32x1" f.	110		1"	43,0	20	9800050942	9800050632
3030125026	125/32x1" f.	125		1"	43,0	20	9800050942	9800050638

**PART C:****Weld-in saddles**

1. Before starting the welding process, check if the aquatherm welding devices and tools meet the requirements of "Fusion Part A".
2. The first step is to drill through the wall of the pipe at the point intended for the outlet by using the aquatherm drill.

branch 25 mm:	Art. no. 9800050940
branch 32 mm:	Art. no. 9800050942
branch 40 mm:	Art. no. 9800050944
branch 50 mm:	Art. no. 9800050946
branch 63 mm:	Art. no. 9800050948
branch 75 mm:	Art. no. 9800050940
branch 90 mm:	Art. no. 9800050940

3. The welding device/saddle welding tool must have reached the required operating temperature of 260 °C (check with reference to "Fusion Part B, item 2").
4. The welding surfaces have to be clean and dry.
5. Insert the heating tool on the concave side of the weld-in saddle tool into the hole drilled in the side wall of the pipe until the tool is completely in contact with the outer wall of the pipe. Next the weld-in saddle spigot is inserted into the heating sleeve until the saddle surface is up against the convex side of the welding tool. The heating time of the elements is generally 30 seconds.
6. After the welding tool has been removed, the weld-in saddle spigot is immediately inserted into the heated, drilled hole. The weld-in saddle should then be pressed on the pipe for about 15 seconds. After being allowed to cool for 10 minutes, the connection can be exposed to its full loading. The appropriate branch pipe is fitted into the sleeve on the aquatherm weld-in saddle using conventional fusion technology.

By fusing the weld-in saddle with the pipe outer surface and the pipe inner wall, the connection reaches highest stability.



Drilling through the pipe wall



Heat-up of pipe...



...and fitting



Joining

**PART D:**  
**aquatherm welding machine**

- One wooden transport box for the welding machine
- aquatherm welding tools diameter 50, 63, 75, 90, 110, 125 mm
- One Allan key and tool change clamp
- One aquatherm thermocolour crayon
- One Installation manual
- One roll stand

The aquatherm welding machine was especially developed for stationary welding of pipe and fittings with an external diameter of 50 to 125 mm. This machine is equipped with a hand crank to facilitate a precise pre-assembly of complicated installation parts.



The fusion is subject to the following data

Pipe-external-Ø	Welding depth	Heating time	Welding time	Cooling time
mm	mm	sec. DVS	sec	min
50	23,5	18	6	4
63	27,5	24	8	6
75	30,0	30	8	8
90	33,0	40	8	8
110	37,0	50	10	8
125	40,0	60	10	8

The General Guidelines for Heated Tool Socket Welding acc. to DVS 2207 Part 11 apply.

**Dimension 160 mm:**

The dimension 160 mm is joined by butt-welding.  
 Detailed information on pages 46 + 47.

**PART D:**  
**Support intervals**

aquatherm red pipe SDR 7.4										SDR 11
Pipe diameter d [mm]										
25	32	40	50	63	75	90	110	125	160	
Support intervals [cm]										
140	160	180	205	230	245	260	290	320	285	

Table to determine support intervals in conjunction with outside diameter.

## PART E: welding machine prisma-light

- with heating plate without tools
  - clamping fixture for fixing the prisma-light, e. g. at the work bench
1. Check machine: temperature lamp blinks after reaching the welding temperature (260 °C), adjust clamping jaws 63–125 mm coarsely. Mark welding depth with the template at the pipe.
  2. Fix the fitting against the clamping jaws.
  3. Place the pipe loose in the opposite clamping jaws.
  4. Position the welding device centrally to the pipe-fitting axis and remove it.
  5. Lock the front calibration knob and drive up the slide as far as it will go.
  6. In this position, push the pipe against the fitting and fix it with the clamping jaws.
  7. Regulate the welding time according to the table on page 38 place the welding device centrally and push the fitting and pipe slowly as far as it will go up to the marking.
  8. The heating time starts when pipe and fitting are completely pushed on the tool. When heating time is complete, return the slide, remove the heating device quickly and join the pipe and fitting.
  9. Consider cooling times from the table on page 38.

More detailed information can be taken from the enclosed operating manuals.

## PART F: Repair

Damaged pipes may be repaired – as already mentioned – by fusion welding (see part B). In addition, the aquatherm red pipe system offers the possibility of repair by repair stick.

The suitable welding tool (Art. no. 9800050307 / 9800050311) and the repair stick (Art. no. 3090000012) are described on page 32.

The installation information is enclosed with the welding tool, but may also be ordered separately.

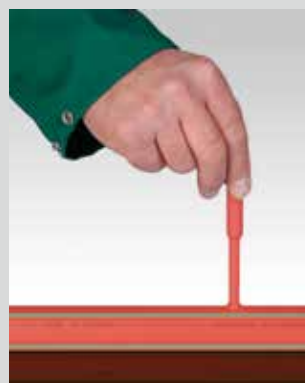

**PART G:**  
**BUTT-WELDING OF PIPE DIMENSION 160 mm**

The following aquatherm red pipe series are available:

aquatherm red pipe SDR 11 MF (fibre composite pipe)

Pipes and fittings are fused, as explained below, by butt welding:

1. Protect your place of work from weather influences
2. Check, if welding machine works properly and heat it up
3. Cut pipes into required length
4. Plastic pipes are aligned and fixed by means of the clamping elements
5. Use the milling machine for planing the pipe end to be plane-parallel
6. Remove the debris and clean the pipe ends with methylated spirit
7. Check if pipes match (tolerance: max. 0.1 x wall thickness)
8. Check width of gap between the two pipes to be welded (tolerance: max. 0.5 mm)
9. Check the temperature of the heating element (210 °C +/- 10 °C)
10. Clean the heating element



Before welding, pipes are cut into the required lengths



Check performance of the welding machine and heat it up



The parts to be welded are fixed and aligned respectively, the milling machine is used



**PART G:****BUTT-WELDING OF PIPE DIMENSION 160 mm**

11. After the heating element has been positioned, the pipes are pushed onto the heating plate with a defined adjusting pressure.
12. After reaching the specified bead height (see tablet), the pressure is reduced. This process marks the beginning of the heating time. This time is for heating up the pipe ends up to the right welding temperature.

Specified bead height: **SDR 11** 160 mm: 1,0 mm

13. When heating time has expired, divide the machine slide, remove heating element quickly and join the pipes (by putting both parts of the slide together).
14. The pipes are fused with the required welding pressure and cooled down under pressure.
15. The welded connection can be unclamped – the welding process is finished.

Additionally please follow the instructions given in the operating manual of the welding machine and observe guideline DVS 2207, part 11.

**Important Note**

1. The welding machines have to be suitable for the welding of pipes with a diameter/wall thickness ratio of up to SDR 11.

aquatherm recommends the following manufacturers of welding machines for butt welding:

Company Ritmo  
Company Widos

2. For hydraulically operated welding machines, the real manometer pressure has to be calculated in consideration of the hydraulic piston area.

This value can be taken from the respective operating manuals.



Positioning of heating element

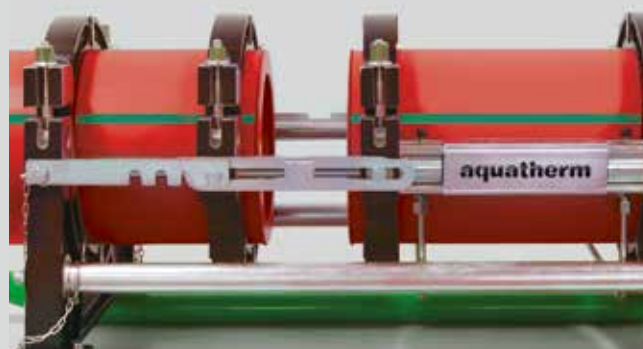

Divide the machine slide, remove heating element



Join the pipes, cool down under pressure



Unclamp and work on...

**Visual inspection of fusion seam – Misalignment and gap width for butt welding**

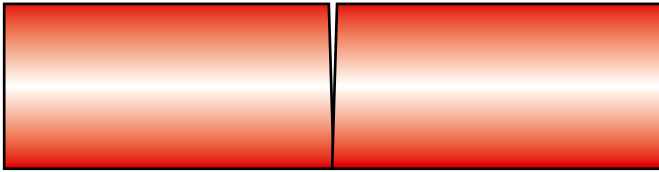

Gap width up to 355 mm outer diameter = 0.5 mm  
 Gap width from 400 mm to 630 mm outer diameter = 1 mm

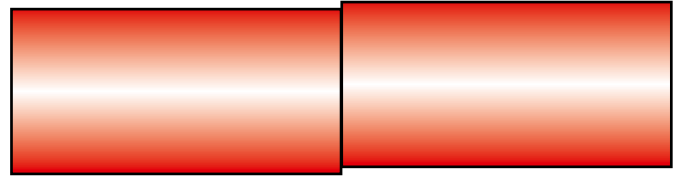

The misalignment cannot be more than 10 % of the wall thickness or max. 2 mm

**Welding defects during butt-welding**

Normally, a bead around the entire circumference is formed at the edge of the socket during the welding process. This bead indicates the proper welding. It is important to assure that the following welding defects are avoided:

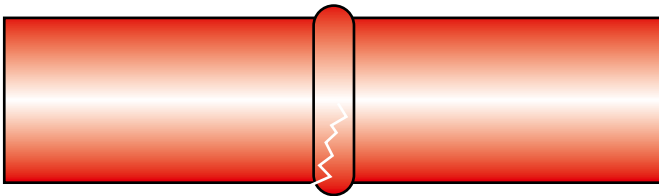

Cracks

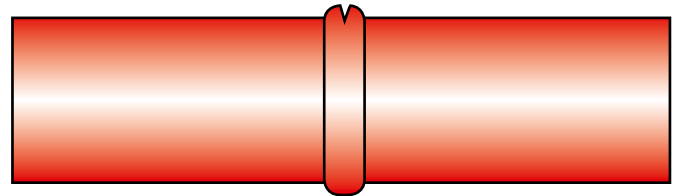

Grooves in the bead

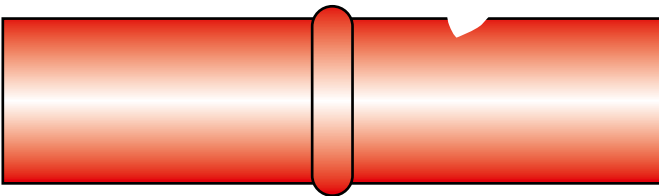

Grooves and scratches

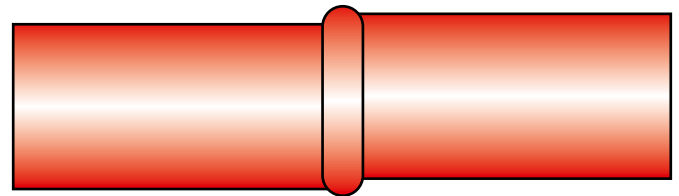

Misalignment of the joining area

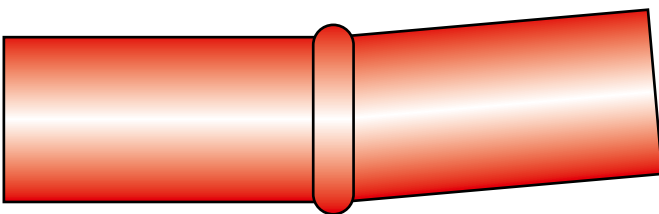

Tilting of the joining area

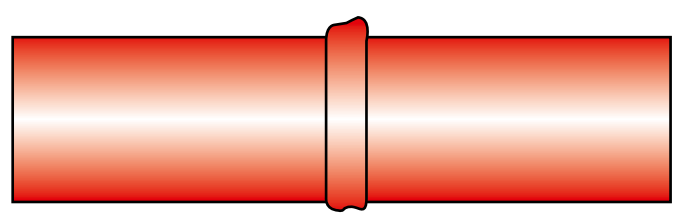

Uneven welding bead

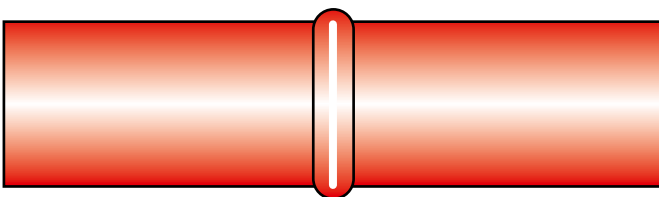

Lack of fusion at the joining area

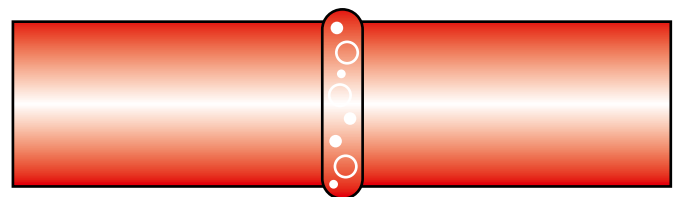

Pores, voids and inclusion of impurities



## Correct butt welded seam

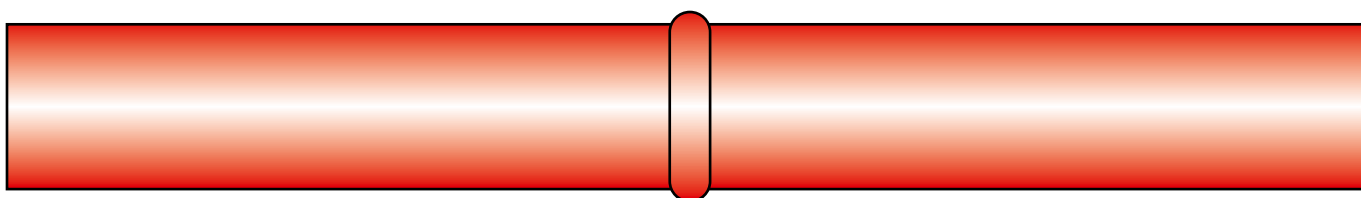

The visual inspection may be only a first indication of the welding seam quality.  
But it is not a replacement for the leak test, which has to be carried out after the completion of the installation.

## Requirements for welding



The immediate welding area is to be protected against bad climatic conditions (e.g. wind, moisture and low temperatures).

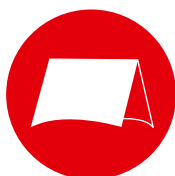

If the pipes are heated unevenly as a result of sun exposure, temperature compensation by timely covering of the welding area is to be created. Cooling down by draft during the welding process should be avoided.



For perfect welding joints, both the welding areas and tools must be clean and free of grease.

**AQUATHERM WELDING PARAMETERS**

**WELDING TEMPERATURE: 210 °C +/- 10 °C**

The calculated drag pressure is added to the adjustment and welding pressure (see description).

**ATTENTION:** When using other welding machines, the pressures P1, P2 and P3 must be adjusted.

**Note:** A reduction of the cooling time up to 50 %, i.e. release of the jointing pressure and removal of the welded part from the welding machine is allowed under the following conditions:

- The joint connection is manufactured under factory conditions and
- The removal from the welding machine and the temporary storage cause only a slight load to the joint connection and
- The joining parts have a wall thickness  $\geq 15$  mm

Further processing with full mechanical load on the joining connection may be effected only after complete cooling down according to the table.

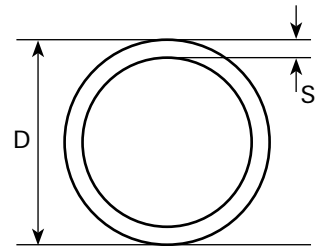

**Excerpt from the DVS 2207 part 11**

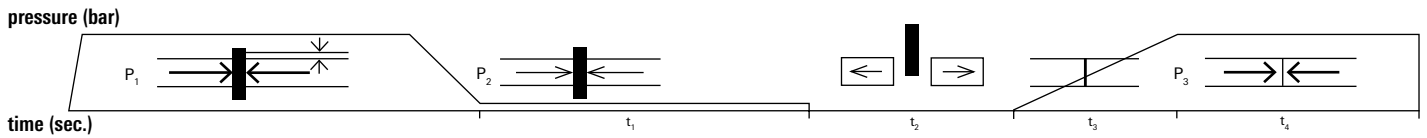



Picture 1

## LAYING OF **AQUATHERM RED PIPE** IN THE CONCRETE

### Part 1:

#### Connecting of pipe work to the aquatherm red pipe sprinkler outlet

The connection is described in picture 1 as follows:

The base part of the sprinkler outlet (1) is screwed with 4 screws on the shuttering.

Brass plug (2), upper part of the sprinkler outlet (3) and aquatherm red pipe connection piece (4) are connected to each other and plugged onto the base part of the sprinkler outlet (1), so that part 3 is flush with the shuttering.

Part 2, 3 and 4 are bolted together and plugged on part 1, so that part 3 is flush with the casing.

The O-ring on part 2 (plug) must always be clean and greased with mounting grease. After the repeated use the O-ring should be replaced.

This applies to the item-no.:

3090000006  
 3090000007  
 3090000008  
 3050000015  
 3050000017  
 3050000020  
 3050000021  
 3050000022

outlet please take from tables on pages 21 and 22!

Colour of plastic sleeve may differ.

#### Detailed information regarding the different dimensions of the sprinkler



**Picture 2**

### LAYING OF **AQUATHERM RED PIPE** IN THE CONCRETE

The aquatherm red pipe sprinkler connection is finished (picture 2).

When removing the shuttering (after pouring of the concrete), the base part of the sprinkler outlet (1) is pulled out of the upper part of the sprinkler outlet (3).

The brass plug (2) is unscrewed from the aquatherm red pipe connection piece (part 4). Now, the upper part of sprinkler outlet (3) must be pulled out of the concrete easily with the aquatherm red pipe extraction tool (Art. no. 9800050290).

The sprinkler connection (picture 3) can be completed very easily. The, acc. to CEA 4001, required distance from the sprinkler head to the completed ceiling, can be accomplished with the compensating fitting from the sprinkler connection thread up to the aquatherm red pipe connecting piece (see drawing page 56).

**Picture 3**



LAYING OF **AQUATHERM RED PIPE** IN THE CONCRETE

Sprinkler outlet consists of the base part, upper part and plug.

For the distance from the deflector to the ceiling, refer to the CEA-4001. You will find compensating joints on page 23.

For further information on the sprinkler outlets please see the tables on pages 21 and 22.

It has to be ensured that the aquatherm red pipe is covered above and below by a minimum 60 mm layer concrete layer.

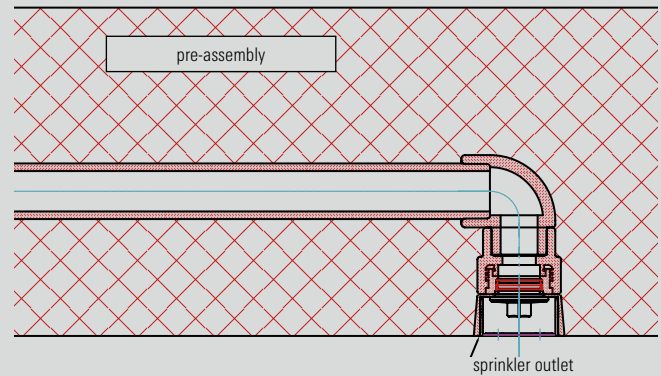

Visible sprinkler

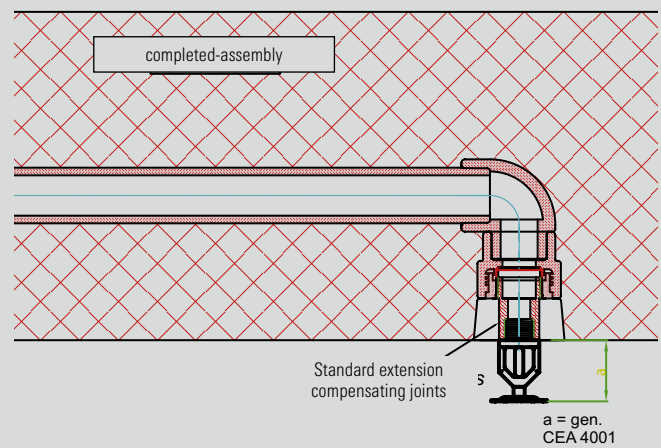

Covered sprinkler

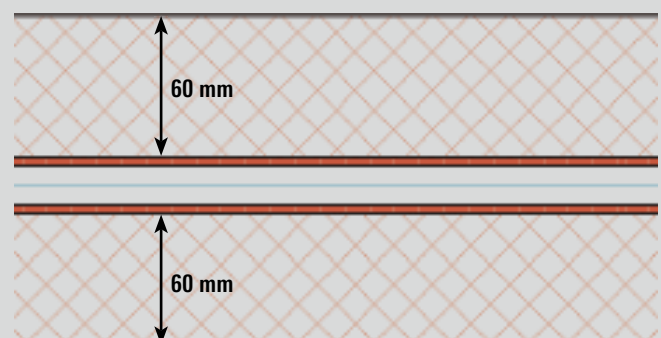
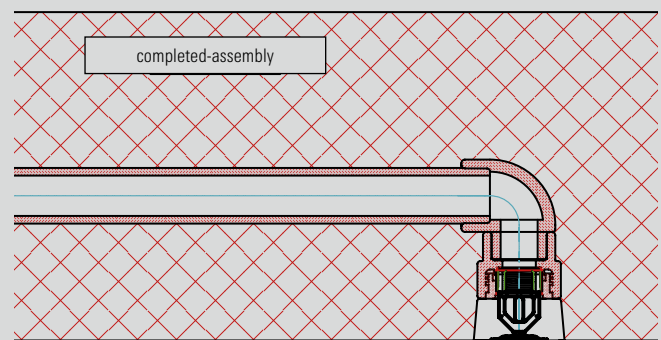

## aquatherm red pipe COMPENSATING JOINT AND ADJUSTING TOOL

**Pipe system made of polypropylene**  
for sprinklers

Compensation joint for use with „aquatherm red pipe“, pipe system made of plastic, VdS approval number: G4050042

The specifications of the technical catalogue „aquatherm red pipe“ and the VdS CEA 4001 (Guidelines for sprinkler systems – planning and installation) are valid.

**Application:**

Correction of non-aligned sprinkler connections in concrete ceilings, maximum correction angle 12° and for compensation of the connection thread to the sprinkler thread (maximum 3 cm) in concrete ceilings, maximum operating pressure 18 bar.

**Important instructions:**

- The compensating joint may only be bent once – multiple reverse bending is not permitted
- Maximum tightening torque for sprinkler = 29 Nm
- Only for the direct connection of the sprinkler

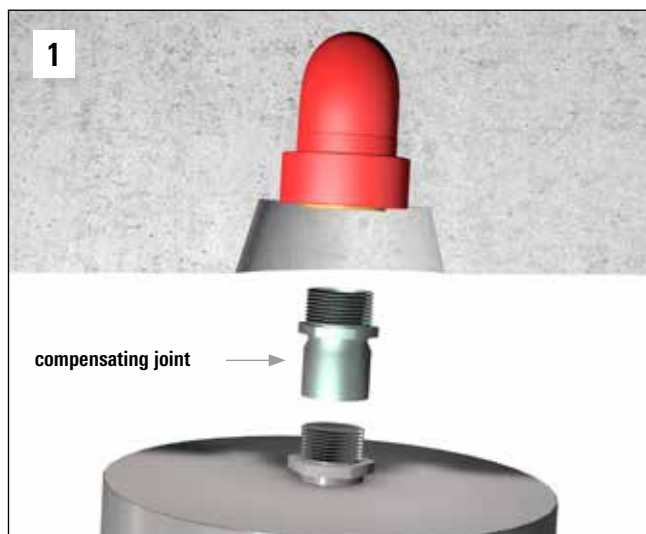

1) If the sprinkler connection protrudes obliquely from the concrete surface, it is possible to align this with the balancing connection. The balancing connection is installed with the provided hexagon in the sprinkler connection thread. A common sealing method for the preparation of waterproof threaded connections is to be used.

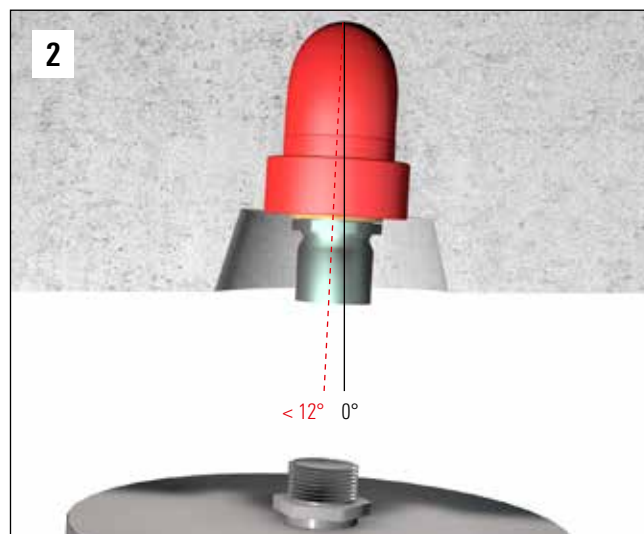

2) This requires a special adjusting tool. It is important to ensure that the bending radius is not more than 12°. The bearing surface of the female thread serves as a reference point on the surface.

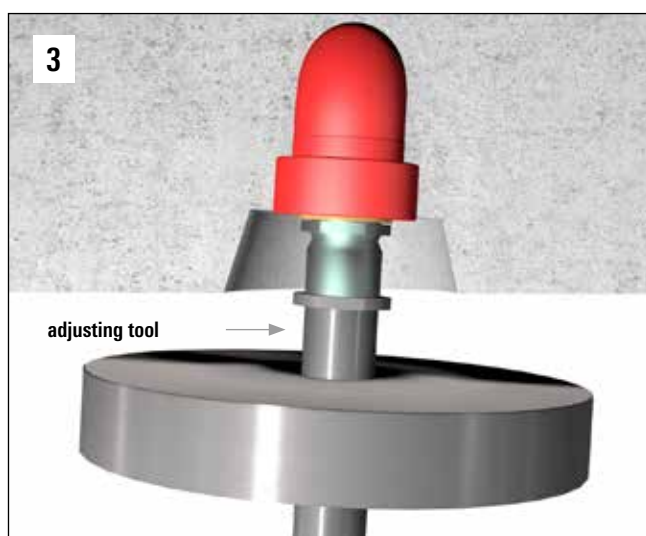

3) The adjusting tool is screwed into the balancing connection with the appropriate adapter.



4) With gentle pressure by hand, the compensating joint is pushed into its position until the plate of the adjusting tool fits proper against the concrete surface and locks into place. Bending back and forth is no longer possible.

**aquatherm red pipe COMPENSATING JOINT AND ADJUSTING TOOL**

Pipe system made of polypropylene  
for sprinklers

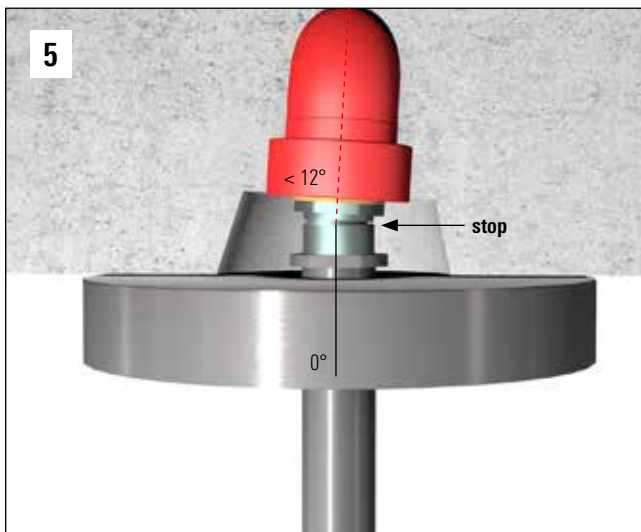

5) The stop limits the bending radius to  $12^\circ$ .

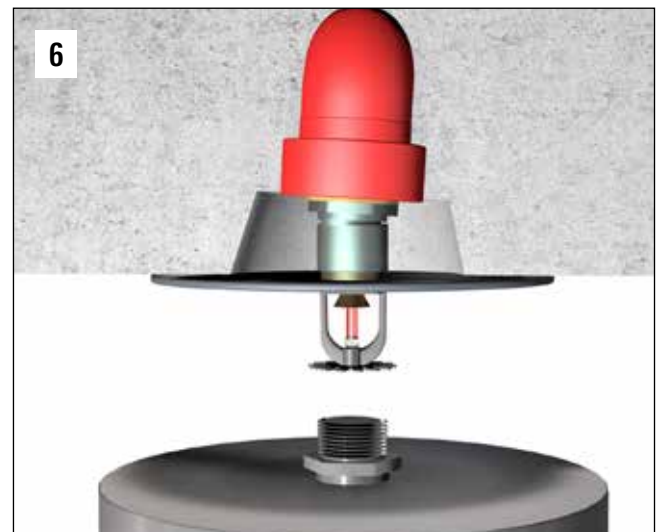

6.) When the sprinkler is installed, the sprinkler connection is subject to the pressure test as usual and tested for leaks. The maximum operating pressure is 18 bar.

Adjusting tool for balancing connection page 34:  
Art. no. 9800050291

Compensating joint page 23:  
Art. no. 9604114230  
Art. no. 9604114232  
Art. no. 9604114234  
Art. no. 9604114236

LAYING OF **AQUATHERM RED PIPE** IN THE CONCRETE

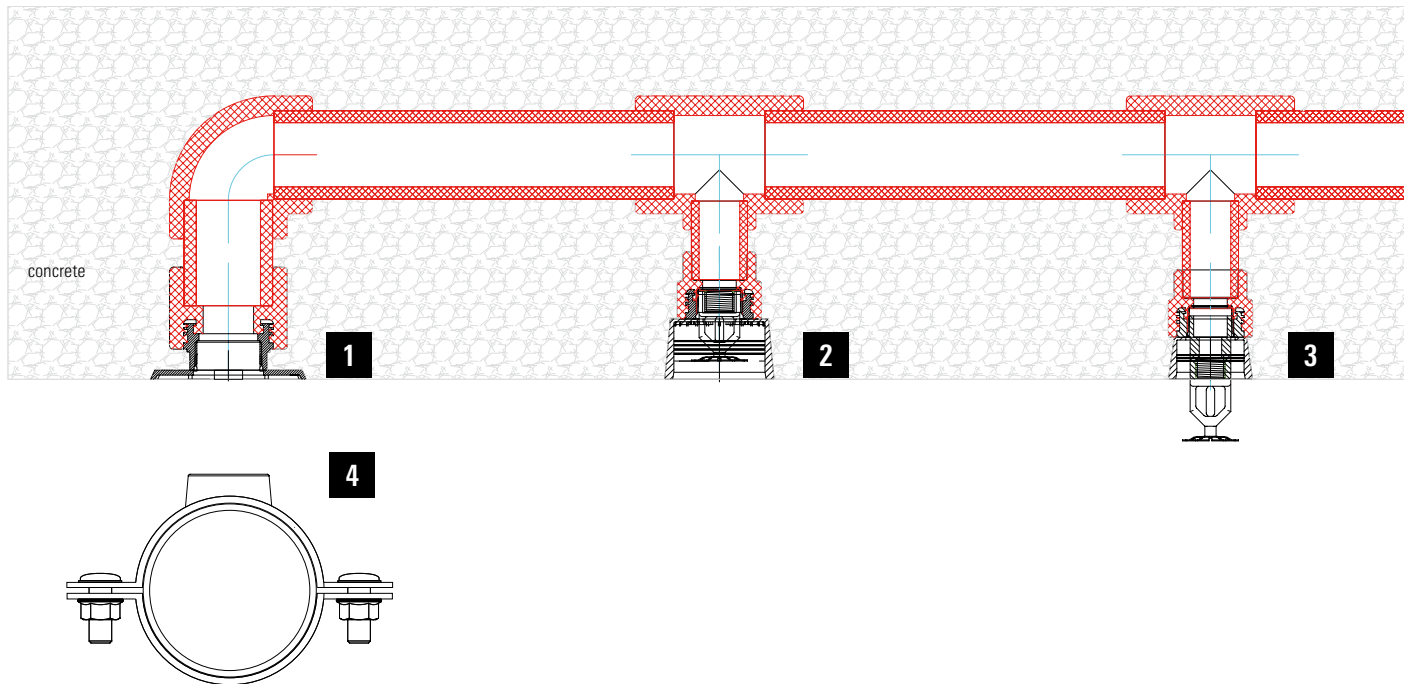

- 1** aquatherm red pipe outlet  
1 1/4", 1 1/2" and 2"
- 2** aquatherm red pipe sprinkler outlet  
for covered sprinkler  
1/2", 3/4" and 1"
- 3** aquatherm red pipe sprinkler outlet  
for visible sprinkler  
1/2", 3/4" and 1"
- 4** aquatherm red pipe to steel pipe adapter

**ATTENTION**

All upper parts of sprinkler outlet must be pulled out of the concrete with the aquatherm red pipe extraction tool (Art. no. 9800050290).



LAYING OF **AQUATHERM RED PIPE** IN THE CONCRETE**Description of the installation in prefabricated concrete ceiling (Filigree ceiling)****Introduction:**

Because precast concrete products are directly shuttered and processed at factory, there remain only some working steps at site. A slab formwork on site is not required. The rapid laying and on-site-installation saves time and costs. Due to the very smooth soffit by the steel formwork table, a plastering is not necessary.

If an installation system is mounted on the steel formwork, this must work precisely, safely and quickly.

The sprinkler outlet of the sprinkler pipe system aquatherm red pipe can be easily mounted on steel formwork. The entire component is assembled in advance by an installation company and delivered to the concrete plant.

In the concrete plant, the sprinkler outlets are measured on the steel formwork and mounted.

**Assembly:**

The base part of the sprinkler outlet is fixed with a magnet (min. holding force 23 kg), or with a hot-melt adhesive (temperature 100 °C) to the steel formwork with reinforcement and also keeps the position during vibrations.

The length of the pipe connecting piece has to be dimensioned so that it is protected by the projecting reinforcement on the transport to the site. The pipe connecting piece is protected by a protective cap and adhesive tape, thereby preventing the penetration of concrete into the interior of the pipe during filling of the mold.



Base part of sprinkler outlet Art. no. 3090000001 for visible sprinklers. Attachment by magnet.



Base part of sprinkler outlet Art. no. 3090000005 for concealed sprinklers. Attachment with hot-melt adhesive.



The upper part of the sprinkler outlet with pipe connection is attached to the base part of the sprinkler outlet.



1. Type of connection: visible sprinkler      2. Type of connection: concealed sprinkler

LAYING OF **AQUATHERM RED PIPE** IN THE CONCRETE

**Description of the installation in prefabricated concrete ceiling (Filigree ceiling)**

**Assembly:**

The mold is filled with concrete and vibrated simultaneously. After shaking the concrete surface is roughened. The component is to dry in a drying chamber.

After drying, the ceiling component is transported to the site and assembled. An installation company can now connect the sprinkler connections with each other and connect them to the supply pipe.

Thus, this method of prefabrication allows shorter construction periods and larger areas. This results in a cost reduction on the one hand and some more flexibility – all in all an increase of economy.





## LAYING OF **AQUATHERM RED PIPE** IN THE CONCRETE

### **Part 2:**

#### **Pressure test of pipe work installation as strength test and leak test**

Please refer to the information on page 62–64.

### **Part 3:**

#### **What must be considered during the concreting process?**

All sprinkler connections have to be locked with cable clips (picture 1) and to underpin (picture 2).

Pipes and sprinkler connections must be fitted with suitable material (see fig. 1) in order to avoid bending. The sprinkler connection (sprinkler outlet) must be in the correct position. If necessary, this should be aligned and re-fastened before concreting.

The pipe sections must be fixed every 1.5 to 2 m in a way (using pipe han-

gers or lacing cord) to avoid sagging or bowing during the concreting process. It is important, that the pipe work is completely embedded without any hollow spaces (cavities).

The entering of the pipes during the concreting process must be avoided. The compacting of the concrete with concrete vibrators in the pipe area should be carried out carefully. Impacts, especially at low temperatures (below +5 °C) must be avoided.

Open pipes and connections must be closed before the concreting.

LAYING OF **AQUATHERM RED PIPE** IN THE CONCRETE**Damaged pipe work in concrete,  
e.g. by drilling work**

Damaged pipe work can be repaired by fusion welding (see aquatherm red pipe sprinkler system, Part B).

The aquatherm red pipe system can also be repaired using the pipe repair stick (see aquatherm red pipe sprinkler system, Part F).

**Part 4:****Bridging of expansion joints**

The expansion of aquatherm red pipe pipes depends on the temperature of the pipe material. Cold water supplies cause hardly any expansion for a normal assembly nor do normal outside temperatures.

The expansion need not to be considered when laying aquatherm red pipe in the concrete. Rising pressures- and tensile stresses are not critical, as they are absorbed by the material.

However, if it is necessary to bridge the expansion joints, the aquatherm red pipes must be equipped with an approx. 25 cm protection pipe at both ends of the joint.

A confirmation of the responsible architect resp. structural designer must certify that no lengthwise movements in the expansion joints can be expected.

Bridging of building joints is not permitted.

The coefficient of expansion of aquatherm red pipe pipes is 0.035 mm/mK  
The coefficient of expansion of concrete is 0.05–0.12 mm/mK.

**Part 5:****Potential equalizing**

The VDE 0190 Part 410 and 540 requires a potential equalizing between all kinds of earth conductors and the existing "conductible" potable and waste water supplies and heating pipes. As aquatherm red pipe is not a conductible pipe system, it cannot be used for potential equalizing and thus needs no earth wiring.

The potential equalizing is made according to VDE-standard from the building parts, which have to be earth wired, directly to the potential equalizing rail to the planned position. The constructor or site manager must advise the client or his representative, that an approved electrician must check, if the aquatherm red pipe installation does not affect the existing electrical protection and earth wiring measurements (VOB Part C, generaltechnical conditions of contract ATV).

**Part 6:****Pressurizing in the aquatherm red pipe supply during the concreting process**

During the concreting process the pipe must be pressurized with the admissible operating pressure, so that a damaged point is visible at once.

After the pressure test the admissible operating pressure is kept by shut off of the respective pipe. The applied measuring devices must grant a correct reading of pressure changes of 0.1 bar.

The pressure measuring device shall be installed at the deepest point of the pipe system.

**Part 7:****Influence of the concrete on the applied compounds**

The aquatherm red pipe pipe system contains all required compounds for a complete system installation. Mixed installation with non-system and/or non-material compounds are not required.

All material is resistant to corrosion. The threads of the aquatherm red pipe sprinkler connection fittings are made from brass (CuZn36Pb2As).

Experiences with this material confirm that the alloy has an excellent resistance against concrete.

The general building regulations have to be complied with locally. If special chemical additives (retarder etc.) are applied, information from the manufacturer of the concrete should be gathered; refer to aquatherm for suitability.

## LEAKAGE TEST

All sprinkler pipelines shall be subjected to a hydraulic pressure test with a test-pressure of 10 bar.

Before the frost period begins, all aquatherm red pipe lines must be drained to prevent frost damage. If there is a risk of freezing, suitable countermeasures must be taken, e.g. heating the building, using antifreeze.

The material properties of the aquatherm red pipes result in an expansion of the pipes during the pressure test. This affects the test result. Due to the thermal expansion coefficients of the aquatherm red pipes the results are influenced additionally. The temperature differences between the pipe and the test medium lead to changes in pressure. Hereby a temperature change of 10 K corresponds to a pressure difference of 0,5 up to 1 bar.

Therefore, pressure testing of the aquatherm red pipe systems should be made with a constant temperature of the test medium. The hydraulic pressure test requires a preliminary, principal and final test.

In the preliminary test a pressure of 18 bar is applied 3 x 5 minutes for the expansion/release of the pipes. Between the cycles the pipe system must be depressurized.

Immediately after the preliminary test the principal test should be performed. The test duration is 15 min. Here, the test pressure (10 bar) may not fall more than 0,5 bar.

After completion of the preliminary and principle test finally the final test

must be performed. The test duration is 60 minutes. Here, the test pressure – read after the principle test – may not fall more than 0,5 bar.

### Measuring of the test pressures

Measuring has to be done with a manometer allowing a perfect reading of a pressure change of 0.1 bar. The manometer has to be placed at the deepest point of the installation.

### Test record

A record of the hydraulic pressure test has to be prepared and signed by the client and contractor stating place and date (see pages 63/64).

### LEAKAGE TEST/PRESSURE DIAGRAM

#### PRELIMINARY TEST

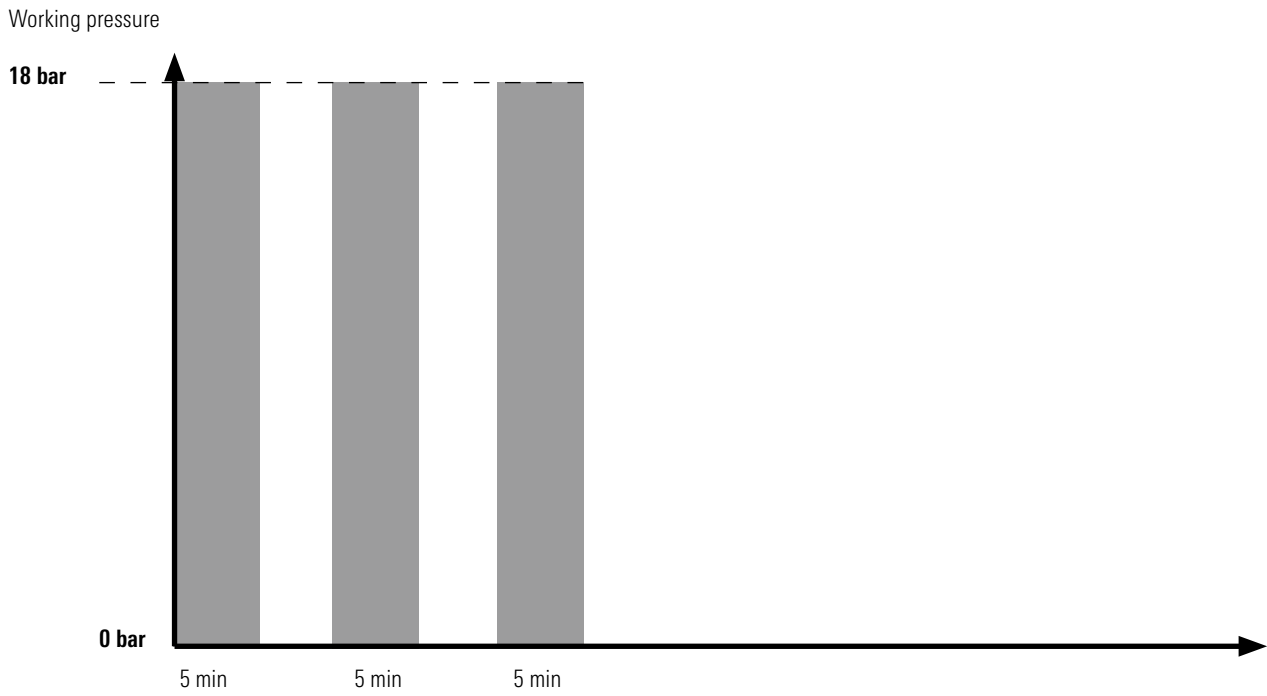

#### PRINCIPAL AND FINAL TEST

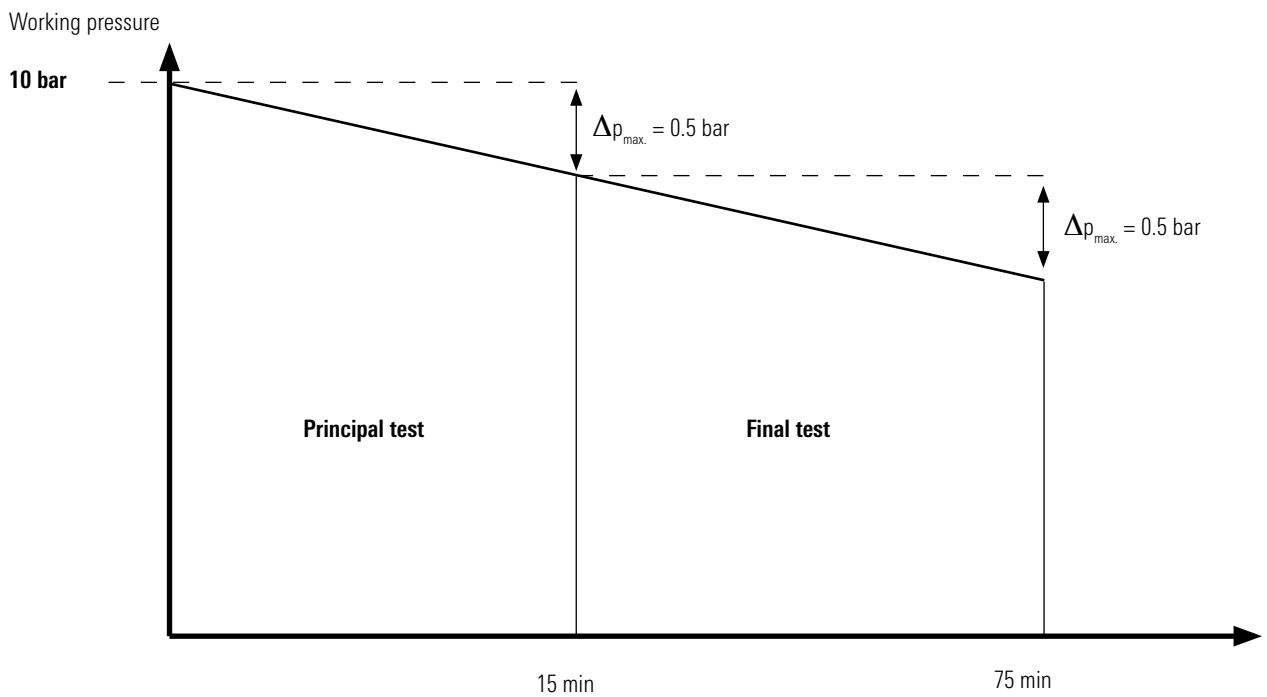

**TEST RECORD AQUATHERM RED PIPE SYSTEM INSTALLATION**

Place: \_\_\_\_\_

Object: \_\_\_\_\_

**Note before the test:**

3x 5 minutes system pressure of 18 bar for expansion/release of the pipes are required.

**Preliminary test**

The pipe system must be unpressurized between each cycle.

<b>18 bar</b>	5 min	realized:	yes	no
<b>18 bar</b>	5 min	realized:	yes	no
<b>18 bar</b>	5 min	realized:	yes	no

**Principal test**

Test pressure: \_\_\_\_\_ 10 \_\_\_\_\_ bar

Pressure decline after 15 min: \_\_\_\_\_ bar **max. 0.5 bar****Final test**

(directly after the principal test, without changing the pressure)

Result principal test: \_\_\_\_\_ bar

Pressure decline after 60 min: \_\_\_\_\_ bar **max. 0.5 bar****Notes:**

---



---



---

Place, Date

Stamp/Signature

**Description of installation**

Place: \_\_\_\_\_

Object: \_\_\_\_\_

**Pipe length:**

- Ø 25 mm \_\_\_\_\_ m
- Ø 32 mm \_\_\_\_\_ m
- Ø 40 mm \_\_\_\_\_ m
- Ø 50 mm \_\_\_\_\_ m
- Ø 63 mm \_\_\_\_\_ m
- Ø 75 mm \_\_\_\_\_ m
- Ø 90 mm \_\_\_\_\_ m
- Ø 110 mm \_\_\_\_\_ m
- Ø 125 mm \_\_\_\_\_ m
- Ø 160 mm \_\_\_\_\_ m

Start of test: \_\_\_\_\_

End of test: \_\_\_\_\_

Test period: \_\_\_\_\_

Test medium:       water       water/glycol

Client: \_\_\_\_\_  
\_\_\_\_\_  
\_\_\_\_\_

Contractor: \_\_\_\_\_  
\_\_\_\_\_  
\_\_\_\_\_

\_\_\_\_\_  
Place, Date

\_\_\_\_\_  
Stamp/Signature



**AQUATHERM RED PIPE SYSTEM**

Inquiry for the chemical resistance of the aquatherm red pipe pipe system

**aquatherm GmbH**

Biggen 5 · 57439 Attendorn · Germany

Phone: +49 2722 950 0

info@aquatherm.de · www.aquatherm.de

**Installer:****Company**

Contact

Street

PC/City

Phone

Fax

E-mail

**Building project:**

---



---



---

**Address:**

Street

PC/City

---

 Place, Date/Signature
**Field of application:****Flow medium**

Operating temperature °C/°F

Working pressure bar/psi

Service life h/d

Concentration %

**Ambient medium:**

Ambient temperature °C/°F

Ambient pressure bar/psi

Data sheets	enclosed	not enclosed
<b>Fluid transported</b>	■	■
<b>Ambient medium</b>	■	■



# aquatherm

state of the pipe

## EXPLANATORY COMMENTS ON THE AQUATHERM GMBH WARRANTY

### 1. Foreword

Thank you very much for making the decision to use a product from aquatherm GmbH, Germany (herein referred to as "aquatherm"). With more than 45 years of experience in the international plastic pipes market, and our trendsetting innovations, we have the expertise needed to offer you engineered piping solutions made in Germany.

The trust placed in the quality of our products has motivated us to offer all pipes and molded, fabricated, machined, and/or assembled parts with a 10-year warranty instead of the standard 2-year warranty required by German law. This extended time covered by warranty is backed by a comprehensive insurance policy from a leading insurance company for our line of business. The warranty period will begin with the date of delivery by aquatherm GmbH, but only comes valid with the successful pressure test, which must be carried out and documented in accordance with the aquatherm specification.

### 2. Scope of warranty

The aquatherm warranty protects you from financial loss proven to be caused by material defects, manufacturing defects and/or aquatherm's consulting/engineering services. The warranty coverage shall apply for the following product groups:

- aquatherm green pipe (fusiotherm and aquatherm ISO)
- aquatherm blue pipe (climatherm and aquatherm ISO)
- aquatherm red pipe (firestop)
- aquatherm black system (climasystem)
- aquatherm lilac pipe (aquatherm lilac)
- aquatherm orange system (aquatherm heating systems)
- aquatherm grey pipe (aquatherm SHT system)
- assemblies fabricated by aquatherm from these product groups

#### 2.1 What is covered by the aquatherm warranty?

The aquatherm warranty covers three aspects of damages: property damage, financial loss and personal injury.

##### 2.1.1 What is property damage?

The damage to or destruction of a tangible item as a result of a defective product (e.g. classic water damages as a result of a leak). As a result of this, the suitability of the tangible item to fulfill its actual purpose is impaired. The term property damage is used if tangible items are damaged or destroyed. Considerable costs can be incurred as a result of property damage, such as renovation costs, repair costs or replacement costs.

##### 2.1.2 What is meant by financial loss?

Financial loss may either be out-of-pocket loss or loss of business. Out-of-pocket financial loss is for example the costs of removing products and installing replacements after damage. Loss of business is the financial disadvantage suffered by an injured party as a result of a damaging event (e.g. lost income as a result of renovations following property damage).

##### 2.1.3 What is meant by personal injury?

If a person suffers physical injury, this is known as personal injury. For the purposes of this document, the coverage of personal injury means the direct medical costs incurred as a result of the injury.

### 3. What is not covered?

Costs related to the damages incurred such as a result of:

- Non-compliance with the operating parameters defined and specified by aquatherm as found in aquatherm's technical documents. In cases of doubt, contact your local aquatherm manufacturer's rep. Exceptions must be provided for, in writing, by a member of aquatherm's engineering team.
- Non-compliance with the installation guidelines as set out in the aquatherm Catalogue, with emphasis to the required installation of aquatherm propriety clipping or other compatible with aquatherm piping.
- Non-compliance with respective National Plumbing Standards and Regulations.
- Joints which were not made in accordance with the aquatherm guidelines, including but not limited to: improper fusion technique, use of contaminated materials or tools, use of faulty or unsuitable tools, use of damaged materials or tools, or any connection made by an installer without sound knowledge of the aquatherm connection techniques and their processes.
- Improperly assembled connections to other pipeline systems and/or components (threads, flanges, stubs, mechanical joints not intended for use with aquatherm PP piping etc.).
- All sealing elements used in the product lines manufactured by aquatherm.
- Tools and accessories sold by aquatherm GmbH are covered for the warranty period by law under the statutory warranty provisions.
- Systems with defective pipeline sections or fittings that were not subjected to the aquatherm pressure test or alternative testing approved by aquatherm prior to start-up.
- Damage to our products caused by incorrect handling after the material has left aquatherm's possession.
- Damage caused or exacerbated by copper in the water resulting from erosion/corrosion or other degradation of copper components in a domestic hot water recirculating system.
- Time delay, caused by incorrect planning, delivery problems and/or incorrect orders.
- Damage caused by entrained air, cavitation and pressure fluctuations.

**Note:** This list only includes the most prominent examples. Other circumstances, which compromise the integrity of the products, may also jeopardize the coverage.



**aquatherm**

state of the pipe

## EXPLANATORY COMMENTS ON THE AQUATHERM GMBH WARRANTY

### 4. How is the amount of compensation under the aquatherm warranty determined?

In the event of a material failure, samples of the damaged/faulty product are collected by the national aquatherm partner to forward them to aquatherm GmbH for examination and analysis. Working in collaboration with the injured party, aquatherm will identify the cause of the damage, and call in external bodies (test institutes, laboratories, assessors, etc.) as needed. If the damage has been caused by a material and/or manufacturing defect or by aquatherm's consulting/engineering services, the underwriter shall quantify the compensation claim for damages. All expenditures associated with the damages for this claim must be verified/recorded in detail and in a verifiable format as a required measure.

### 5. How much is the maximum coverage?

For the first 5 years of the warranty period, property damage, personal injury and financial loss is covered for the sum of €20 million per insurance claim. Total coverage for all claims made in a year is a maximum of €40 million. For years 6-10 of the warranty period, these coverage amounts are €7.5 and €15 million respectively.

### 6. Why is the coverage stated in Euro?

The insured manufacturer, aquatherm, as well as the insurer, are both based in the EU, so that their agreements are issued in Euros (€). Since exchange rates fluctuate, the exchange rate current on the date of compensation shall apply.

### 7. What is the channel of communication for notifying claims under warranty and making inquiries about them?

Warranty claims have to be made to aquatherm via the national aquatherm GmbH partners. Information about the progress of the claim will only be released by the aquatherm partner or aquatherm GmbH.

### 8. Legal note

If a discrepancy or conflict arises between this document and the underlying insurance policy, the latter shall in all cases prevail.

If a discrepancy or conflict arises between this translated document and the German document, the German document shall in all cases prevail.

### 9. Information about avoiding damage

#### I) **Manufacture under certified quality level**

As a trusted manufacturer, aquatherm works to a certified quality standard (ISO 9001); constant internal quality controls are part of the daily routine. In addition to this, all employees are integrated into a quality assurance program. As a result of this, products failing to comply with our high standards are quickly identified and removed from our product range.

#### II) **Preventing damage caused by incorrect handling**

Our products must be handled conscientiously and carefully when they are delivered from our production plants. Experience shows that most damage is caused in transit, storage and/or when working on site. At this point we would draw close attention to the fact that correct handling contributes to maintaining the product quality.

#### III) **Work is to be carried out by qualified installers**

Installation defects are easy to avoid. Our training courses teach the correct techniques in detail for working with our products. In doing so, particular importance is attached to work being carried out attentively and with care. The work of installers trained by us or our aquatherm partners is much more reliable and carried out much more efficiently.

**For a safe connection, we recommend using only aquatherm PP products in a piping system. Mixing with other PP piping systems should be avoided.**

June 2020  
aquatherm GmbH, Biggen 5, 57439 Attendorn, Germany

**James Simon Galery: Visitor center of the Museum Island**

Berlin, Germany

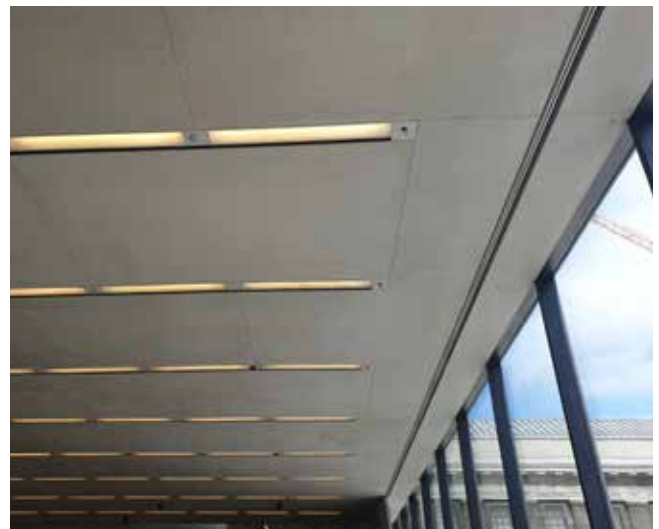

**Office Building "Römischer Hof"**

Berlin, Germany

**Federal Archives**

Berlin, Germany



**Spreeturm**

Berlin, Germany

Photo: NAS Real Asset Management GmbH



Photo: NAS Real Asset Management GmbH

**The European Patent Office**

Munich, Germany



**Public Utility, technology center**

Munich, Germany





**GEWA Tower**

Fellbach, Germany



**aquatherm Factory**

Attendorf, Germany



Assembly precast concrete ceiling



Prefabrication concrete wall

**Dornier Museum**

Friedrichshafen, Germany



**Schwabinger Tor**

Munich, Germany



**Pandion Vista, luxury apartments**

Cologne, Germany



**AachenMünchener Insurance**

Aachen, Germany



**Unionsbräu**

Dortmund, Germany



**Zalando Headquarters**

Berlin, Germany



**Kö-Bogen 1: Office, shopping and event center**

Düsseldorf, Germany



**Kö-Bogen 2: Office, shopping and event center**

Düsseldorf, Germany



**Hans Sachs Building**

Gelsenkirchen, Germany



**HDI-Gerling Insurance Headquarters**

Hannover, Germany

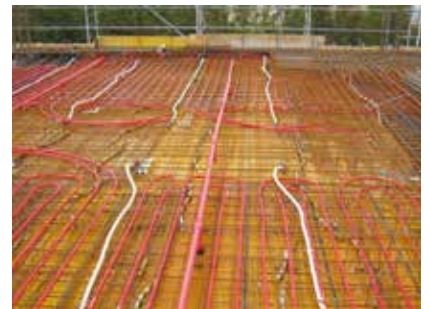



**Kristallbau**

Hamburg fish market, Germany



**Office Building Rödingsmarkt**

Hamburg, Germany



**Überseequartier**

Hamburg, Germany



## Tanzende Türme

Hamburg, Germany

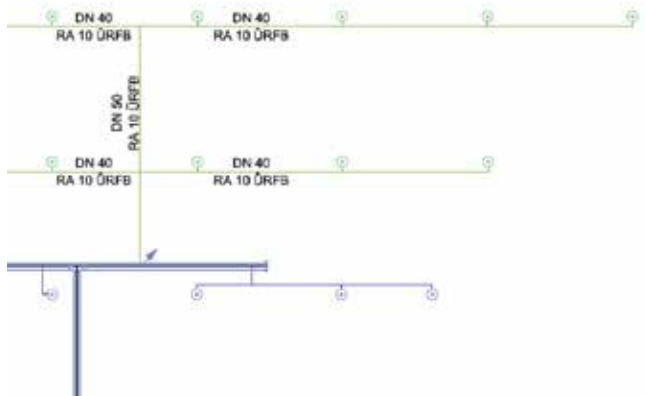

## Metropolis

Hamburg, Germany



**Coffee Plaza**

Hamburg Hafencity, Germany

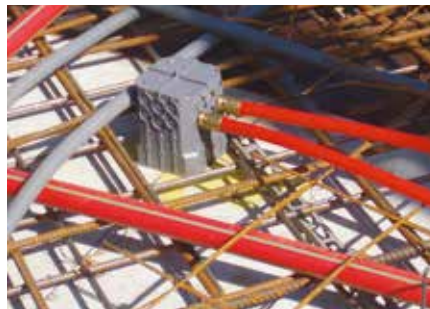

**Spiegel Building**

Hamburg, Germany



**KTM Motohall: Exhibition Center**

Mattighofen, Austria



Photo: @sebasromero



Photo: @sebasromero



Photo: @sebasromero



Photo: Accuro GmbH

**HYPOT Headquarters**

Innsbruck, Austria



**Riu Plaza de España: Hotel**

Madrid, Spain

Photo: Riu Hotels & Resorts



Photo: Riu Hotels & Resorts

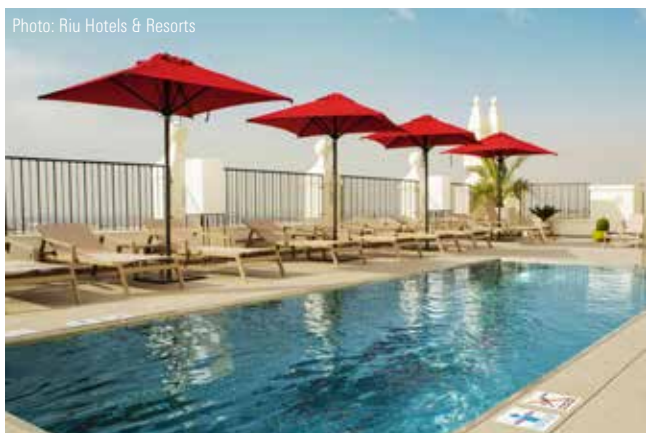
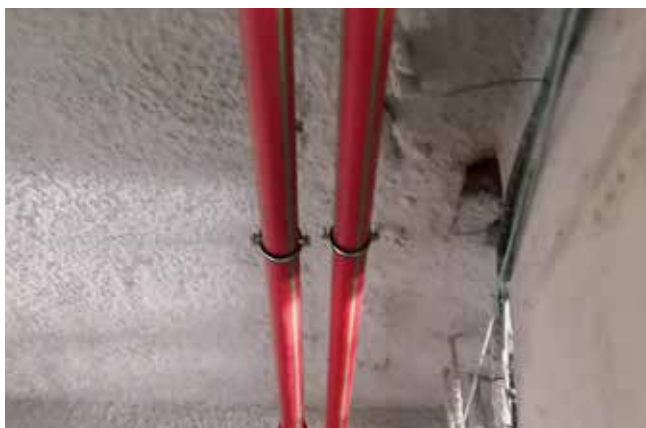

Photo: Riu Hotels & Resorts



**Hotel**

Sweden



**Carpet warehouse**

Turkey





**Raschal Centre for children surgery and traumatology**

Moscow, Russia



**Shopping Centre**

Moscow, Russia



**Office Building**

Moscow, Russia



## TERMS AND CONDITIONS

---

**Important note regarding our sales, warranty and delivery conditions:**

**Our sales and delivery conditions (issue: 2014) as well as the contact details of our technical sales department and our representatives can be found on our website [www.aquatherm.de](http://www.aquatherm.de).**

Errors, misprints and technical modifications reserved. With the appearance of this catalogue all previous issues become void.

---

aquatherm GmbH, 2020. This technical information is protected by copyright. Reproductions are prosecuted.



Management  
System  
ISO 9001:2015  
ISO 14001:2015  
ISO 50001:2018  
[www.tuv.com](http://www.tuv.com)  
ID 0091005348

## aquatherm GmbH

Biggen 5 | 57439 Attendorn | Tel.: +49 2722 950 0

[info@aquatherm.de](mailto:info@aquatherm.de) | [www.aquatherm.de](http://www.aquatherm.de)

Order-No.: 99000000057  
Edition: 01.2022

**aquatherm red pipe** - Pipe system made of polypropylene for fire sprinkler systems